



LINEAR MOTION TECHNOLOGY

MR Miniature Linear Guide Series
ST Miniature Stroke Slide Series

* cpc reserves the right to revise any information(technical details) any time without notice, for printing mistakes or any other incidental mistakes. We take no responsibility.



About us

The Chieftek Precision Co.,Ltd (abbreviated as **cpc**) place emphasis on recruiting talents with both technique and character. The core team continuously develop the high-quality key components of linear motion devices, system module and control module. The top goal of **cpc** is to provide the products with highest quality and latest technology to help our client to transfer from era of industrial production into smart manufacturing.



Angelika Chen
CHAIRPERSON & CEO



Anton Hsu
PRESIDENT

At early stage, the main focus of the **cpc** was on miniature linear guide, which is majorly applied on precision measurement, electronics industry, automation and semi-conductor semiconductor equipment. We account for high market share in medical industry and have received compliments, and well recognized by worldwide customers.

With the growth and innovation of **cpc**, we are able to supply linear guides with all sizes. Meanwhile to fulfill the demand of market, **cpc** successfully developed the linear motor with high thrust density and efficacy, as well as the DD motor with highest torque efficiency. Besides, to enhance the performance of customer's machine, we further developed the AC, DC driver, magnetic encoder...etc. **cpc** is now a key supplier of mechanics, electronics and control module in industry related to linear and rotary motion. We will keep optimizing and innovating our manufacturing process, elevating the production capacity meanwhile to reduce the defect rate and production cost. The goal of our technology development is to fulfill the demand of customer, provide the product with high quality, high reliability and high added value, to help the customer to build an industry with smart manufacturing.



Time line of major developments

- 1998 ● Established
- 2000 ● Official production of the MR size 5~15 Miniature Guide Series
- 2004 ● Extension into size 3 and 2 miniature linear guide production
- 2005 ● Establishment of factory operations in the Tainan Science Park
- 2007 ● Production of the ARC/HRC Series Ball Type Standard Size Linear Guides which have achieved ISO 9001:2000 certification
- 2008 ● Establishment of **cpc USA** (Chieftek Precision USA Co., Ltd.)
Establishment of **cpc Kunshan**, China (Chieftek Machinery Kunshan Co., Ltd.)
Production of the full range Ironless linear Motor P series
- 2010 ● Establishment of **cpc Europa GmbH**
Achievement of ISO 9001:2008 certification
- 2011 ● New factory expansion
- 2013 ● Wide ball type linear guide production
- 2014 ● Achievement of ISO 14001:2000 certification
Achievement of OHSAS 18001:2007 certification
Achievement of CNS 15506:2011 certification
Production of full range Ironcore Linear Motor C Series
Mass production of CLS compact linear Motor Stage Series
Standard 4-Row Roller-type ARR/HRR/LRR Linear Guide Series announced
- 2015 ● Mass production of the TC1 AC Linear Motor Servo Driver
Mass production of the CLMS Core Type Linear Motor Stage
- 2016 ● MMLS-Linear Motor Stage.
Established CSM Maschinen GmbH.
- 2017 ● Passed the ISO9001: 2015 certification.
Passed the ISO14001: 2015 certification.
- 2018 ● The establishment of **cpc** factory operations in tree valley park

Contents

Selection method.....P01

1. Product Introduction.....P02~P06

2. Technical Information.....P07~P22

 2.1 Precision.....P07

 2.2 Preload.....P08

 2.3 Lubrication.....P09~P11

 2.4 Friction.....P12

 2.5 Load capacity and rating life.....P13~15

 2.6 Line chart.....P16~17

 2.7 Loading, Lifetime, & Rigidity Analysis Software of Linear Guide System (LLRAS).P18~22

3. Installation Illustration.....P23~25

4. Ordering Information.....P26~27

5. Dimensions and Specifications.....P28~48

6. Carbon Steel.....P49~50

ST Miniature Stroke Slide series.....P51~57

1. Product Introduction.....P52~P53

2. Technical Information.....P54~P55

3. Ordering Information.....P55

4. Dimensions and Specifications.....P56~57

Linear Guide Service Life Calculation and Model Selection.....P58

The Flow Chart of Model Selection

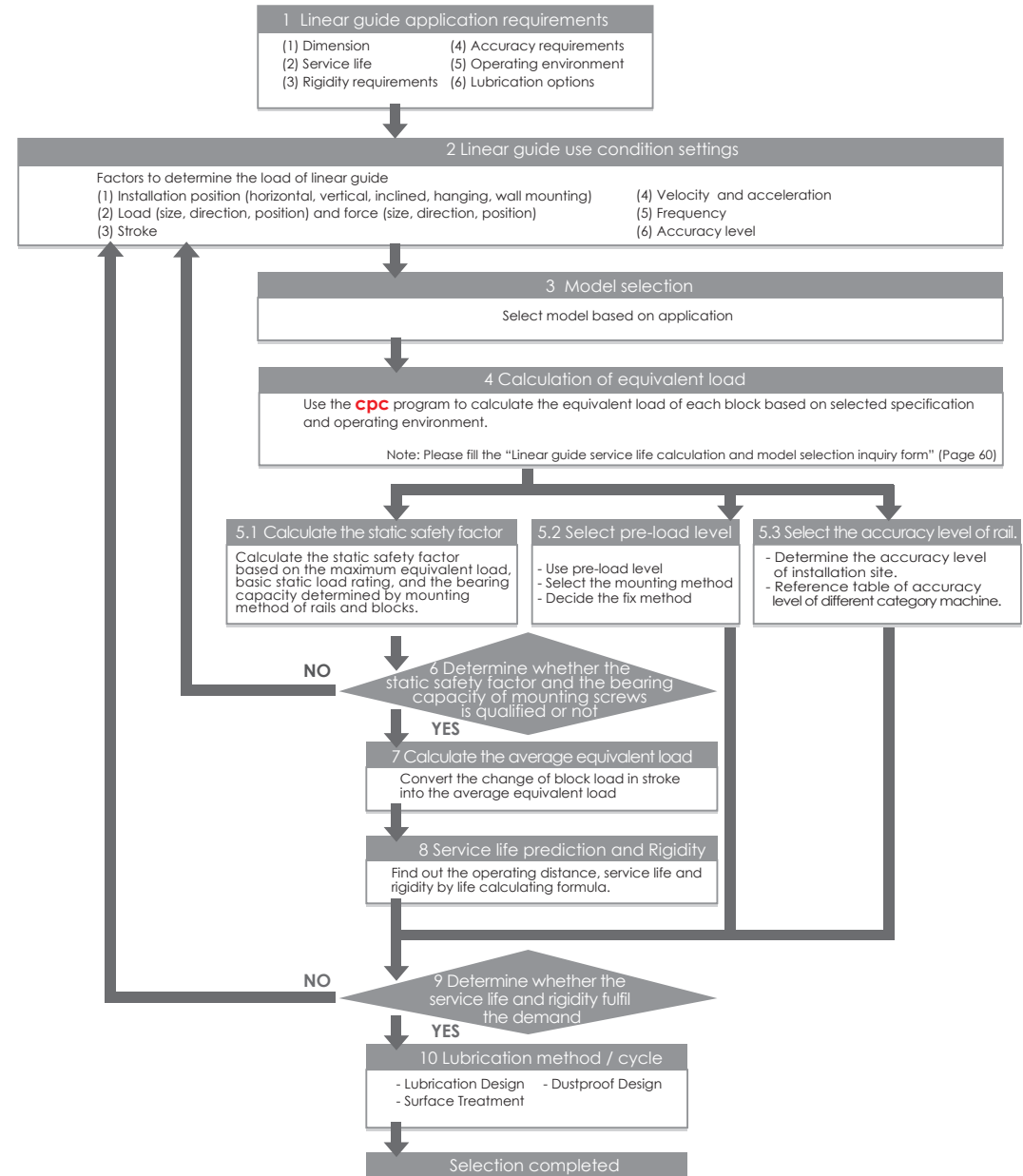

1. Product Introduction

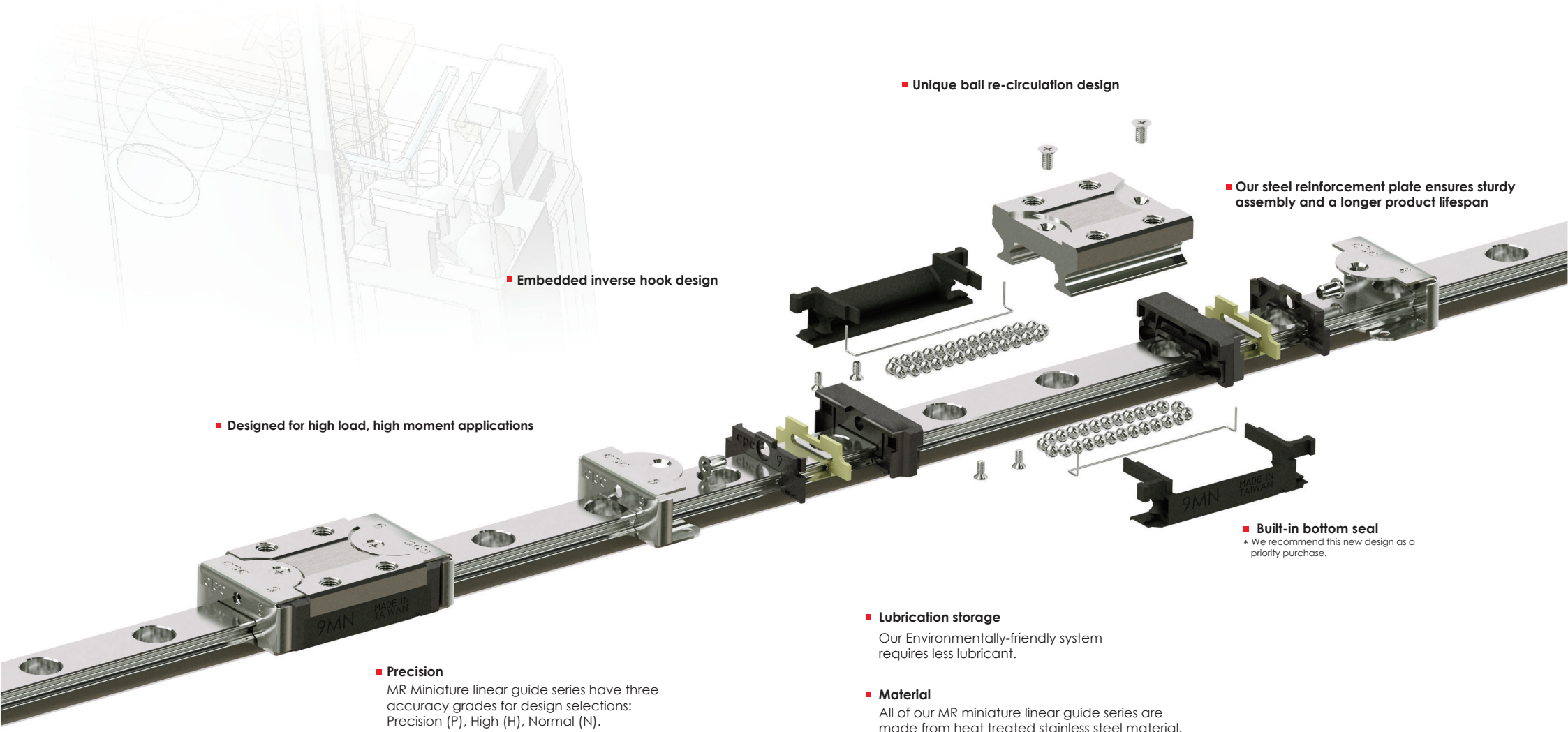

■ Embedded inverse hook design

■ Designed for high load, high moment applications

■ **Precision**

MR Miniature linear guide series have three accuracy grades for design selections: Precision (P), High (H), Normal (N).

■ Unique ball re-circulation design

■ Our steel reinforcement plate ensures sturdy assembly and a longer product lifespan

■ **Built-in bottom seal**

* We recommend this new design as a priority purchase.

■ **Lubrication storage**

Our Environmentally-friendly system requires less lubricant.

■ **Material**

All of our MR miniature linear guide series are made from heat treated stainless steel material.

1. Product Introduction

Dustproof design

SS series-end seal

The standard end seal design can be hermetically sealed and dustproofed. This extends the product lifespan, reduces lubrication grease consumption, and ensures a long-lasting lubrication effect. The special seal slip design also ensures a low friction force so as not to affect the product's running smoothness.

Environmentally friendly lubrication design

ZZ series-end seal and lubrication pad

The two ends of the runner block feature a hermetic lubrication grease injection design. This is capable of bringing the lubrication grease to the raceway via continuous steel ball circulation, thereby achieving an effective long-term lubrication effect. A built-in lubrication pad can also be utilized toward prolonging lubrication further for long-term motion, reducing maintenance costs while demonstrating a superior lubrication capability during short stroke motion.

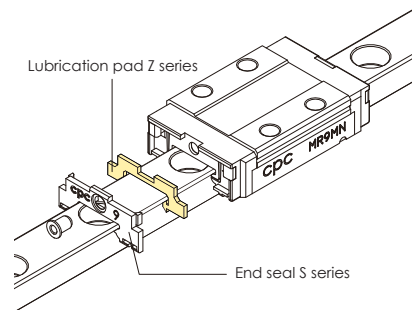

End reinforcing design

EE series-end seal and reinforcement plate

This series utilizes two stainless steel reinforcement plates to cover the two plastic ends of the slide block completely and stainless steel screws to secure the upper and lower sides of the runner steel block, thereby strengthening the rigidity and increasing the coverage area of the end cap. This ensures faster running speeds while a gap sealing design between the reinforcement plate and slide rail enables an added wiping function.

Running speed $V_{max}=5m/s$, $a_{max}=300m/s^2$
(60m/s² can be reached without prepressing)

EZ series - end seal, reinforcing plate and lubrication pad

The built-in lubrication pads at the two ends of the runner block conform to environmental protection requirements and reduce maintenance costs.

EU series - end seal, stainless steel bottom seal and reinforcement plate

The stainless steel bottom seal protects the runner block from unnecessary damage caused by collision with foreign objects. Due to this runner block series having our strongest protective capability, its use is recommended for environments with many iron scraps around.

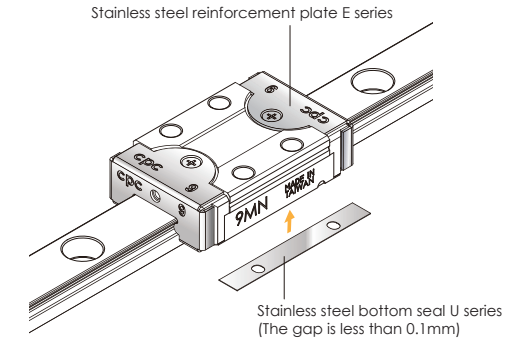

UZ series - end seal, stainless steel bottom seal, reinforcement plate and lubrication pad

The lubrication pad can provide highly rigid runner blocks with better lubrication and grease storage capabilities, and reduce re-greasing time.

Brand new U series

Features: the built-in bottom seal does not affect the friction resistance if a clearance is smaller than 0.1mm.

Brand new UE series

SU series - end, bottom seals

In addition to a normally equipped end seal, our newly designed runner block is equipped with an extra bottom seal. This prevents foreign matter from entering via the lower side of the runner block into the running rail, thereby extending the working life of the runner block.

* the new design is recommended for priority purchase.

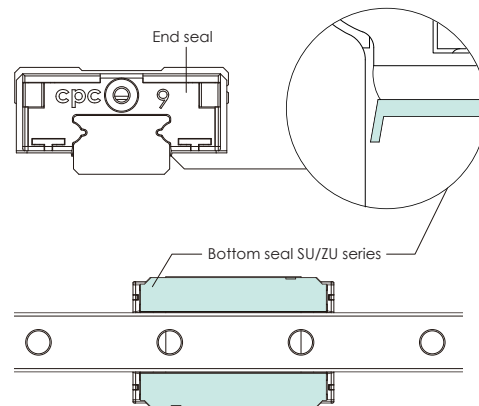

ZU series - end, bottom seals and lubrication pad

A newly designed bottom seal can prevent lubrication grease from spilling below the runner block. In addition, a built-in mounted lubrication pad further strengthens the series' grease-saving effects while extending its re-greasing interval.

* the new design is recommended for priority purchase.

SUE series - end seal, bottom seal and reinforcement plate

our new design includes an in-built bottom seal. This strengthens the runner block's bottom dustproofing capability while its stainless steel reinforcement plate prevents hard and rigid objects from striking at the plastic cap from the end position. This is why its dustproofing effect is the strongest among all of our product series.

* the new design is recommended for purchase in priority.

ZUE series - end seal, bottom seal, reinforcing plate and lubrication pad

The newly designed bottom seal protects lubrication grease from spilling below the runner block. with our built-in lubrication pad, an additional grease saving effect is attained, further prolonging our product's re-lubrication timeframe.

* the new design is recommended for priority purchase.

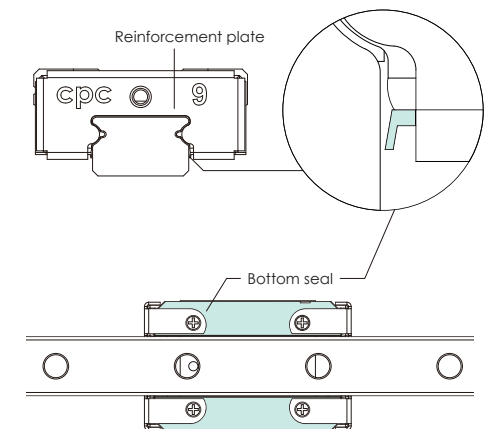

1. Product Introduction

Embedded inverse hook design for reinforced mechanical integration

When the runner block is in motion and changing direction, the circulating stainless steel balls inside the raceway generate impact force against the plastic end cap. As the demand for rapid motion in the automation industry has increased, **cpc** has invented inverse plastic hooks to tightly secure our miniature blocks by effectively distributing the applied stress over a larger area.

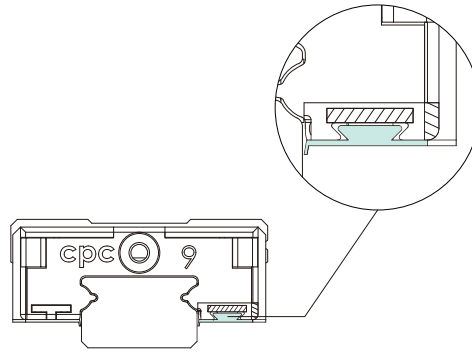

Brand new design

Suitable for :
High speed belt driven mechanisms
High speed carrier designs
Automation linkage between stations

High load and high moment capacity

The MR Miniature Linear Guide Series is designed using two rows of recirculating balls. The design uses a Gothic profile with a 45° contact angle to achieve an equal load capacity in all directions. Within the restriction of limited space, larger stainless steel balls are used to enhance load and torsion resistance capacity.

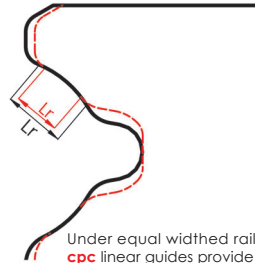
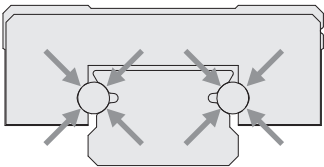

Under equal width rails, the black line indicated **cpc** linear guides provide greater surface contact as compared to competing products (indicated with the red-dotted line).

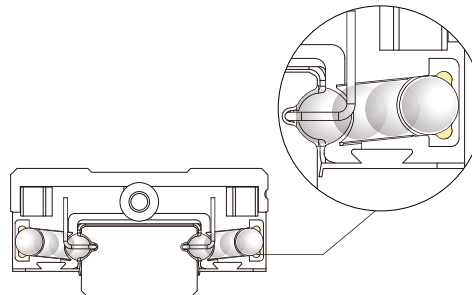

Dust Proof Design

Our standard design comes equipped with an end seal that effectively restricts dust contamination and prolongs lubrication, ensuring longer product life. Our specially-designed low friction seal slips do not affect running smoothness.

2. Technical Information

2.1 Precision

Accuracy

MR miniature linear guide series have three accuracy grades (P,H,N) for your choice.

Table of accuracy

Accuracy grades (µm)		Precision		
		P	High H	Normal N
Admissible height H dimension Tolerance	H	± 10	± 20	± 40
Height variation for different runner blocks on the same rail position	ΔH	7	15	25
Admissible width W dimension tolerance	W ₂	± 15	± 25	± 40
Width variation for different runner blocks on the same rail position	ΔW ₂	10	20	30

Speed

The maximum speed for the standard MR-SS/ZZ,SU/ZU type is:

V_{max} = 3 m/s

Maximum acceleration

a_{max} = 250 m/s²

(If preload is at V0, capability of reaching 40m/s²)

The maximum speed for the standard MR-EE/EZ,EU/UZ,SUE/ZUE type is:

V_{max} > 5 m/s

Maximum acceleration **a_{max} = 300 m/s²**

(If preload is at V0, capable of reaching 60m/s²)

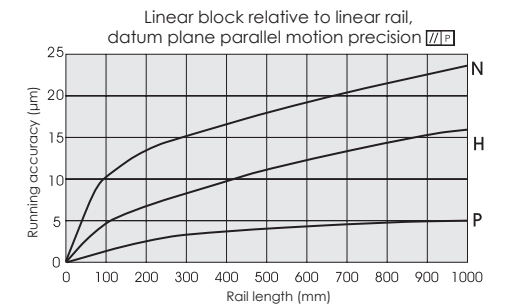

2. Technical Information

2.2 Preload

Preload

The MR Miniature Linear Guide series has three degrees of preload capacity: V0, VS and V1 (as described in the preload table below.) Appropriate preload levels can enhance the stiffness, precision, and torsion resistance performance of the linear guide. But an inappropriate application thereof can also negatively affect the product life and its motional resistance levels.

Table Preload

Preload type	Model code	Clearance (µm)						Application
		3	5	7	9	12	15	
Clearance	V0	+3-0	+3-0	+4-0	+4-0	+5-0	+6-0	Very smooth
Standard	VS	+1-0	+1-0	+2-0	+2-0	+2-0	+3-0	Smooth and high precision
Light preload	V1	0--0.5	0--1	0--3	0--4	0--5	0--6	High rigidity Minimizes vibration High precision Load balance

Operating Temperature

The MR Miniature Linear Guide can operate in a range of temperatures from -40°C~ + 80°C. For short term operation, it can reach up to +100°C.

Friction Force in Average

Unit: N

Block		without endseals(SS/SU)			endseal (SS/SU)	Oilpad supplied with Oil (ISO /VG 32)
size	weight (g)	Preload class				
		Clearance (V0)	VS	V1 (min-max)		
MR 3MN	0.9	0.02	0.03	0.06(max)	0.05	-
MR 5MN	3.5	0.03	0.04	0.08(max)	0.05	0.05
MR 7MN	8	0.03	0.05	0.10-0.20	0.05	0.15
MR 9MN	18	0.04	0.12	0.20-0.50	0.05	0.15
MR 12MN	34	0.04	0.16	0.30-1.00	0.05	0.20
MR 15MN	61	0.10	0.20	0.40-1.50	0.05	0.20

Unit: N

Block		without endseals(SS/SU)			endseal (SS/SU)	Oilpad supplied with Oil (ISO /VG 32)
size	weight (g)	Preload class				
		Clearance (V0)	VS	V1 (min-max)		
MR 3WN	3.4	0.04	0.06	0.08(max)	0.05	-
MR 5WN	6	0.10	0.15	0.20(max)	0.10	0.05
MR 7WN	19	0.10	0.25	0.30-0.70	0.10	0.20
MR 9WN	37	0.20	0.30	0.40-1.10	0.10	0.20
MR 12WN	65	0.20	0.35	0.40-1.40	0.10	0.30
MR 15WN	137	0.40	0.50	0.60-1.80	0.20	0.40

Unit: N

Block		without endseals(SS/SU)			endseal (SS/SU)	Oilpad supplied with Oil (ISO /VG 32)
size	weight (g)	Preload class				
		Clearance (V0)	VS	V1 (min-max)		
MR 3ML	1.2	0.02	0.03	0.08(max)	0.05	-
MR 5ML	4	0.04	0.06	0.10(max)	0.05	0.05
MR 7ML	14	0.04	0.07	0.10-0.30	0.05	0.15
MR 9ML	28	0.06	0.14	0.20-0.60	0.05	0.15
MR 12ML	51	0.08	0.20	0.40-1.30	0.05	0.20
MR 15ML	90	0.20	0.20	0.50-2.80	0.05	0.20

Unit: N

Block		without endseals(SS/SU)			endseal (SS/SU)	Oilpad supplied with Oil (ISO /VG 32)
size	weight (g)	Preload class				
		Clearance (V0)	VS	V1 (min-max)		
MR 3WL	3.4	0.04	0.06	0.08(max)	0.05	-
MR 5WL	8	0.10	0.15	0.20(max)	0.10	0.05
MR 7WL	27	0.10	0.30	0.30-0.80	0.10	0.20
MR 9WL	51	0.20	0.30	0.40-1.40	0.10	0.20
MR 12WL	93	0.20	0.35	0.50-1.50	0.10	0.30
MR 15WL	200	0.40	0.60	0.80-3.10	0.20	0.40

2.3 Lubrication

Function

When operating the linear guide under sufficient lubrication conditions, a one-micron layer of oil forms at the contact zone, separating the loaded rolling components and the raceway. Sufficient lubrication will:

- Reduce friction
- Reduce wear
- Reduce oxidation
- Dissipate heat and increase service life

Lubrication Caution

- ZZ/ZU/EZ/UZ/ZUE Lubrication Storage block
 1. The block already contains lubricants which can be directly installed on the machine, without the need for additional washing.
 2. When first washing the blocks, please do not soak them in the lubricant before both the detergent and cleaning naphtha within are totally dry. The block is ready for installation only after the lubrication storage is full of the lubricant.
- The linear guide must be lubricated for protection before first time use. Contaminants of any kind, weather liquid or solid, should be avoided.
- The runner block should be moved back and forth during lubrication.
- The lubricant can be added either manually or automatically directly onto the rail raceway.
- The lubricant can be injected into the lubrication holes on either end of the runner block.
- A thin layer of observable lubricant should be maintained on the surface of the rail .
- Re-lubrication must be completed before contamination or discoloration of the lubricant occurs.
- Please notify us if product is intended for use in acidic, alkaline, or clean room applications.
- Please contact our technical department for lubrication assistance if the runner block is intended for use in a wall mount configuration.
- The re-lubrication interval must be shortened if the travel stroke is < 2 or > 15 times the length of the steel body of the runner block.

Grease lubrication

When grease lubrication is applied, we recommend synthetic oil-based lithium soap grease with a viscosity between ISO VG32-100.

Oil lubrication

For oil lubrication, we recommend synthetic oils CLP, CGLP (based on DIN 51517) or HLP (based on DIN 51524) with a viscosity range of between ISO VG32-100 and a working temperature range between 0°C~+70°C. (We recommend ISO VG10 for use in lower temperature environments.)

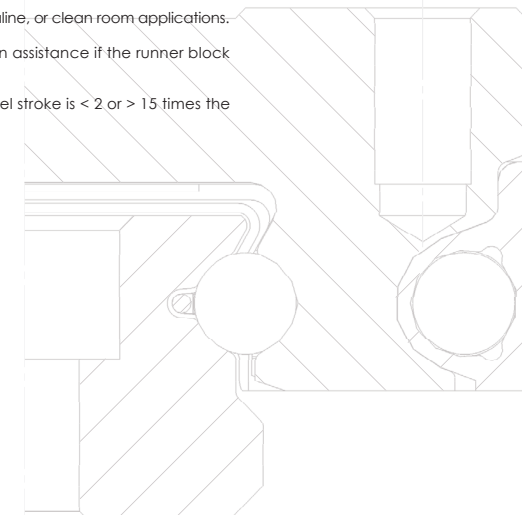

2. Technical Information

2.3 Lubrication - continued

Re-lubrication

- Re-lubrication shall be applied before the lubricant in the block is contaminated or changes color.
- The amount of the lubricant applied should be 1/2 of the first lubrication. When applying lubricant, this should be done until it seeps out from the device.
- Re-lubrication shall be applied under steady operating temperature, with the runner block moved back and forth throughout for optimum distribution.
- If the stroke is smaller than twice or greater than 15 times the steel body length of the block, the re-lubrication interval shall be shortened.

Table 1

Model code	First lubrication (cm ²)	Model code	First lubrication (cm ²)
-	-	2 WL	0.03
3 MN	0.02	3 WN	0.03
3 ML	0.03	3 WL	0.04
5 MN	0.03	5 WN	0.04
5 ML	0.04	5 WL	0.05
7 MN	0.12	7 WN	0.19
7 ML	0.16	7 WL	0.23
9 MN	0.23	9 WN	0.30
9 ML	0.30	9 WL	0.38
12 MN	0.41	12 WN	0.52
12 ML	0.51	12 WL	0.66
15 MN	0.78	15 WN	0.87
15 ML	1.05	15 WL	1.11

Re-lubrication Interval

The re-lubrication interval depends on individual use, as the speed, load, stroke length and operating environment are all factors. Careful observation of rails and blocks is the basis to determine the optimal re-lubrication interval; as a rule of thumb, re-lubricate at least once per year. Do not apply water-based coolant liquid on the linear rails or slide. Inject lubricant through injection holes on both ends of the runner block with the recommended **cpc** brand injector.

Lubrication grease

- 00 For general applications
- 01 For low-friction, low-noise applications
- 02 For clean room applications
- 03 For clean room and vacuum environment applications
- 04 For high-speed applications
- 05 For micro-oscillation applications

Lubrication oil

- 11 For general applications, ISO V32-68

Ordering of the lubrication injector

LUB - 01 - 18G	
Lubricant :	Needle model :
00	21G: 5M/5W
01	19G: 7M/7W
02	18G: 9M/9W
03	18G: 12M/12W
04	15G: 15M/15W
05	
11	

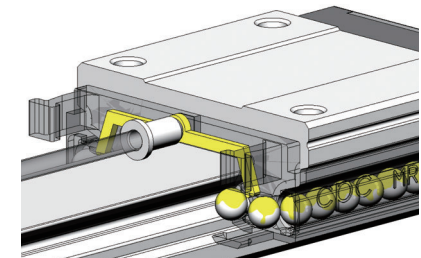

Lubricant amount: 10ml



2. Technical Information

2.4 Friction

Friction

The MR Miniature Linear Guide Series has low-friction characteristics with a stable and minor starting friction.

Sealing Design

The MR Miniature Linear Guide Series are enclosed by end seals on both ends of the runner block. Optional side seals can also create an all-around sealing system.

Friction

$$F_m = \mu \cdot F \quad \text{---(1)}$$

F Load (N)

F_m Friction (N)

The MR Miniature Linear Guide Series friction factor is app $\mu = 0.002\text{--}0.003$

Friction Factors

- Sealing system.
- Collision between the balls during operation.
- Collision between the balls and the return path.
- Number of balls in the gothic arch load zone.
- Resistance from lubricant to ball pressure.
- Resistance caused by contaminants.

2.5 Load Capacity and Rating Life

Static Load Rating C₀

Measuring the static load of the travel force along the acting direction, the maximum stress between the rolling balls and raceway is as follows:

- If the curvature radius is lower or equal to 0.52: 4200 MP
- If the curvature radius is equal or higher to 0.6: 4600 MP.

Note: Under maximum stress levels, a permanent deformation will be generated at the contact point. This corresponds roughly to about 0.0001 times the rolling element diameter. (The above is according to ISO 14728-2)

Static load safety factor calculation

$S_0 = C_0/P_0$ ---(11)	Operation condition	S ₀
$S_0 = M_0/M$ ---(12)	Normal operation	1 ~ 2
$P_0 = F_{max}$ ---(13)	Load with vibration or impact	2 ~ 3
$M_0 = M_{max}$ ---(14)	High accuracy and smooth running	≥ 3

Static load P₀ and moment M₀

The permissible static and applied static load of the MR Miniature Linear Guide Series is limited by:

- The static load of the linear guide.
- The permissible load of fixed screws.
- The permissible load for the connected parts of the mechanism.
- The static load safety factor required for the application.

The equivalent static load and static torque are the largest load and torque, please consult with formulas (13) and (14).

Static load safety factor S₀

In order for the linear bearing to permanently withstand potential deformation while delivering a guaranteed accuracy and reliable motion, the static load safety factor, S₀ should be calculated with formulas (11) and (12).

S₀ static load safety factor
 C₀ basic static load in acting direction N
 P₀ equivalent static load in acting direction N
 M₀ basic static moment in acting direction Nm
 M equivalent static moment in acting direction Nm

2.5 Load capacity and rating life - continued

Dynamic load rating C_{100B}

For constant sized and directional loads, when the linear bearing is under such a load, the rating life of a linear guide can reach a theoretical travel distance of 100km. (The above is according to ISO 14728-1.)

Rating life calculation

$$C_{50B} = 1.26 \cdot C_{100B} \quad (2)$$

$$C_{100B} = 0.79 \cdot C_{50B} \quad (3)$$

$$L = \left(\frac{C_{100B}}{P} \right)^3 \cdot 10^5 \quad (4)$$

$$L_h = \frac{L}{2 \cdot s \cdot n \cdot 60} = \frac{L}{v_m \cdot 60} \quad (5)$$

L	= rating life for 100,000 meter travel distance	(m)
L_h	= rating life in hours	(h)
C_{100B}	= dynamic load rating	(N)
P	= equivalent load	(N)
s	= length of stroke	(m)
n	= stroke repetition	(min ⁻¹)
v_m	= average speed	(m/min)

Rating Life L

90% survival rate for an individual linear guide or a batch of identical linear guides in standard product material and operation conditions is calculated as above (according to ISO 14728-1 standards). When using the 50km travel standard, the dynamic load rating will exceed the ISO 14728-1 standard value by 20% or more. Formula (2) describes the relationship between the two load ratings.

Calculation of rating life

Formulas (4) and (5) can be used when the equivalent dynamic load and the average speeds are constant.

Equivalent dynamic load and speed

If the load and speed are not constant, it is important to take into account the actual load and speed as both will influence life expectancy.

Equivalent dynamic load

If there is a change in load only, the equivalent dynamic load can be calculated according to formula (6).

Equivalent load capacities and speed calculation

$$P = \sqrt[3]{\frac{q_1 \cdot F_1^3 + q_2 \cdot F_2^3 + \dots + q_n \cdot F_n^3}{100}} \quad (6)$$

$$\bar{v} = \frac{q_1 \cdot v_1 + q_2 \cdot v_2 + \dots + q_n \cdot v_n}{100} \quad (7)$$

$$P = \sqrt[3]{\frac{q_1 \cdot v_1 \cdot F_1^3 + q_2 \cdot v_2 \cdot F_2^3 + \dots + q_n \cdot v_n \cdot F_n^3}{100 \cdot \bar{v}}} \quad (8)$$

$$P = |F_x| + |F_y| \quad (9)$$

$$P = |F| + |M| \cdot \frac{C_0}{M_0} \quad (10)$$

Equivalent speed

If there is a change in speed only, the equivalent speed can be calculated according to formula (7).

If there are changes in both load and speed, the equivalent dynamic load can be calculated according to formula (8).

P	= Equivalent dynamic load	(N)
q	= Percentage of stroke	(%)
F_i	= Discrete load steps	(N)
\bar{v}	= Average speed	(m/min)
v	= Discrete speed steps	(m/min)
F	= External dynamic load	N
F_y	= External dynamic load, vertical	N
F_x	= External dynamic load, horizontal	N
C_0	= Static load rating	N
M	= Static moment	Nm
M_0	= Static moment in direction of action	Nm

Combined Equivalent Dynamic Load

If the linear guide bears the load from arbitrary angles so that the acting force does not conform to horizontal and vertical directions, its equivalent dynamic load is calculated as shown on formula (9).

Under the condition with the moment

If the linear guide bears the load and the moment simultaneously, its equivalent dynamic load is calculated with formula (10).

According to ISO 14728-1, when equivalent dynamic load tolerance rates below $\leq 0.5C$, $P \leq C_0m$, a reliable product life value can be calculated.

Single Block Bearing the Moment

For a given structure, if the block needs to bear torque moments from M_p and M_y directions, the maximum moment that the block can withstand while still maintain smooth running conditions measures at about 0.3-0.1 times the static moment rating. The higher the preload, the higher the loading value and vice versa.

In the case of any design questions, please contact the **cpc** technical department.

2. Technical Information

2.6 Line chart

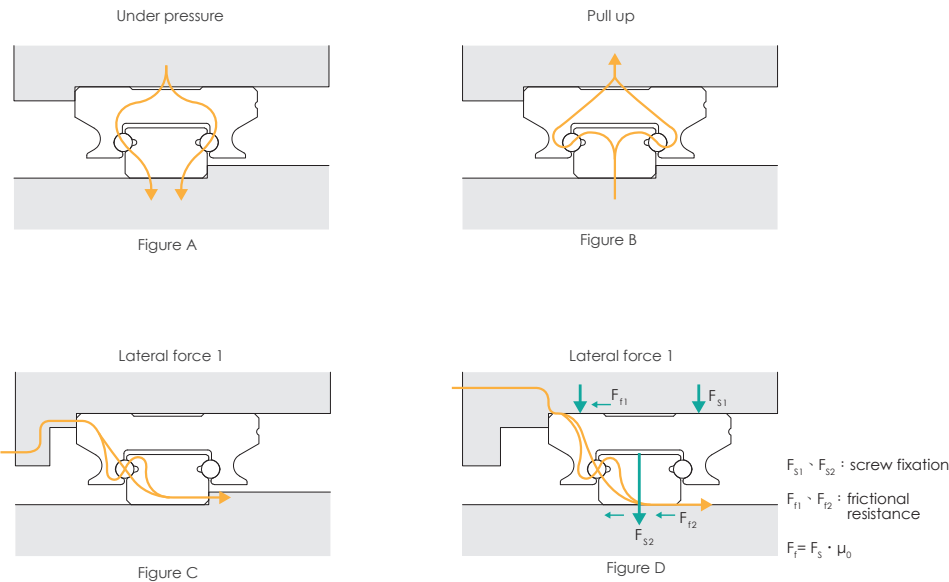

As can be seen from the three diagrams in Figure A to Figure D, when subjected to upward, downward and lateral loads, the force flow will be distributed to the two ball transfer.

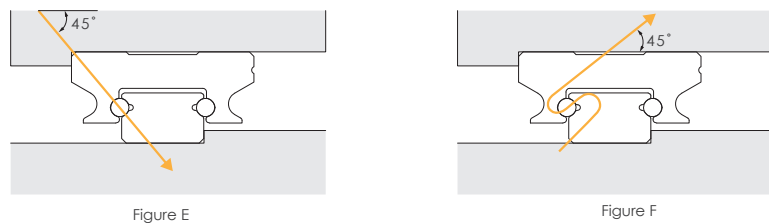

As shown in the two diagrams in Figures E and F, the load acting on the 45-degree angle has the greatest effect on the system's life because the transfer of force is limited to a single row of balls.

When the load is applied horizontally or vertically ($0^\circ, 90^\circ, 180^\circ, 270^\circ$), the equivalent load of the slide is equal to the actual load. When the load angle is 45° , its equivalent load is approximately 1.414 times that of the main direction. (as shown in formula (13))

When the same load is at different angles, the comparison of equation (13) and the actual equivalence load is as shown in the following figure.

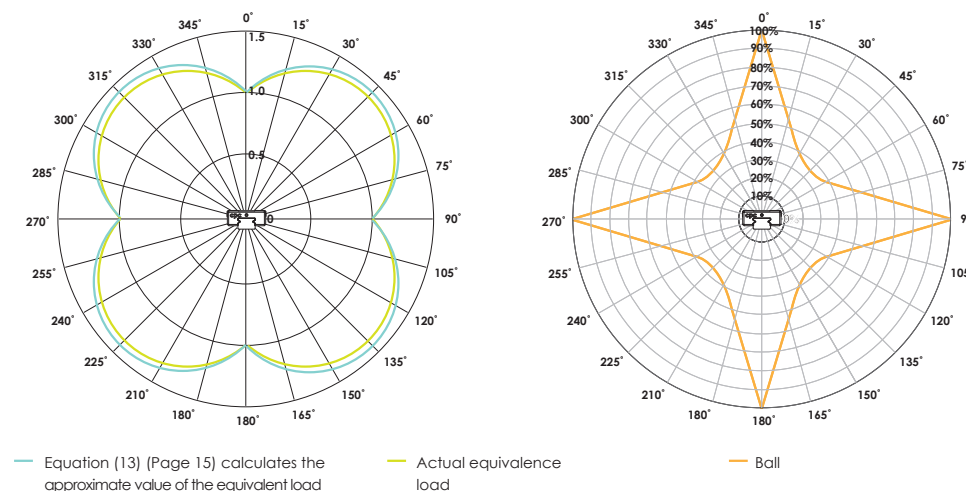

Therefore, in order to increase the service life of the linear system, it should be installed in the appropriate direction to bear the load. Otherwise, the service life will be greatly reduced, as shown in the figure below. Since the relationship between life and load is as the power of formula (8), when the acceptance angle is 45° , the service life will be significantly reduced.

The following is the life L comparison chart (in %) for different angles under the same load.

The following is a comparison diagram of the equivalent load approximate value and the actual equivalent load calculated by Equation (14). The example uses the MR15MN linear guide to withstand a fixed down pressure and the torque gradually increases. The above figure shows the torque in the Mr direction. The figure below shows the torque in the $M_{b/y}$ direction.

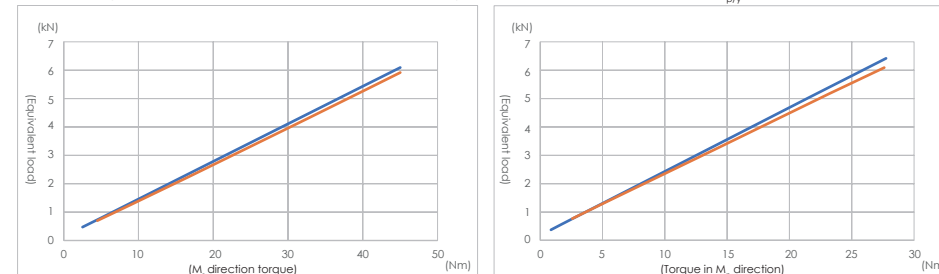

2. Technical Information

2.7 Loading, Lifetime, & Rigidity Analysis Software of Linear Guide System (LLRAS)

1. The load exert on the linear guide would varies due to the position of object's center of gravity, thrust position and acceleration / deceleration induced inertia.
2. Because of the uneven distribution of force on linear guide, when a certain part of rail, or when a force exertion point is damaged, the linear guide system would start to malfunction.
3. The point with largest force exertion must be identified, and be used reference to calculate the equivalent load, to ensure the reliability of service life calculation.

Ball

$$Q \propto F (Dw^{\frac{1}{2}}, \delta^{\frac{3}{2}}, C_5^{\frac{3}{2}})$$

Q = load
 δ = amount of rolling element deformation
 Dw = ball diameter
 C_5 = geometric constant

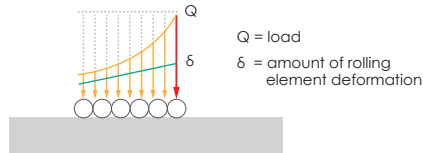

As shown by the formula, the relationship between the amount of deformation of the rolling element and load is not linear. A larger deformation will cause the non-linear increase of load.

Therefore by using the **cpc** self-developed program, the "Loading, Lifetime, & Rigidity Analysis Software of Linear Guide System (LLRAS)", a precise service life estimation can be derived. This is done by optimum calculation of deformation and rotation when a linear guide experience load, in this case the accurate equivalent load can be calculated.

Loading, Lifetime, & Rigidity Analysis Software of Linear Guide System (LLRAS)

Data input guidance

1. Set the slide rail position, the number of slides on the slide

Rail number	Rail1	Rail2
Block number	Block1	Block2
Block Y coordinate	100	0
Block category	MR	MR
Size	15	15
Model code	MR15MN	MR15MN
Preload value	VS	VS

Preload type	Model code	Clearance (um)					
		3	5	7	9	12	15
Clearance	VG	+3-0	+3-0	+4-0	+4-0	+5-0	+5-0
Standard	VS	+1-0	+1-0	+2-0	+2-0	+2-0	+3-0
Light preload	V1	0--0.5	0--1	0--3	0--4	0--5	0--6

- Variables can be set:
- Linear guide span
 - Linear guide height
 - Linear guide placement angle
 - Platform inclination
 - Number of block

2. Set the carriage size model

Block number	Rail1	Rail2	Rail2
Block1	Block2	Block1	Block2
Block Y coordinate	100	0	100
Block category	MR	MR	MR
Size	15	15	15
Model code	MR15MN	MR15MN	MR15M
Preload value	VS	VS	VS

- Variables can be set:
- Block span
 - Block type
 - Block preload

3. Set the exercise state

First movement interval	Second exercise interval	The third sports section
Acceleration interval V & a	Constant speed interval V & S	Deceleration interval V & a
Known information		
Final speed V (m/s)	0.5	0
Accelerations (m/s ²)	0.000	-5
Exercise time (s)	0.100	0.200
Travel S (mm)	25.000	100
		25.000
		150

- Variables can be set:
- Working status
 - Drive position
 - Actuation frequency

2. Technical Information

2.7 Loading, Lifetime, & Rigidity Analysis Software of Linear Guide System (LLRAS)

4. Set external force and torque position, size, direction

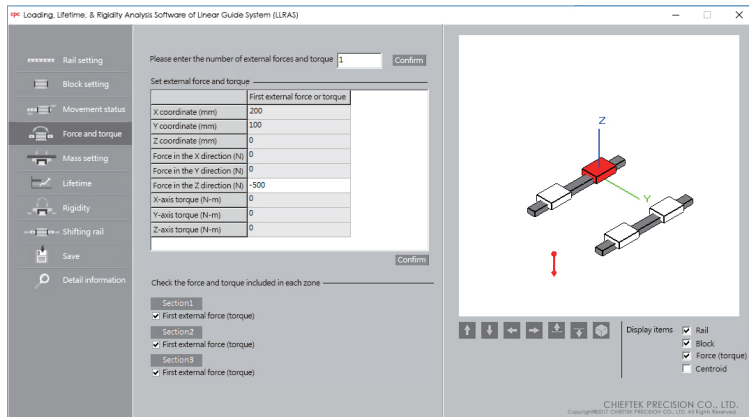

6. The calculated results and setting of linear guide system

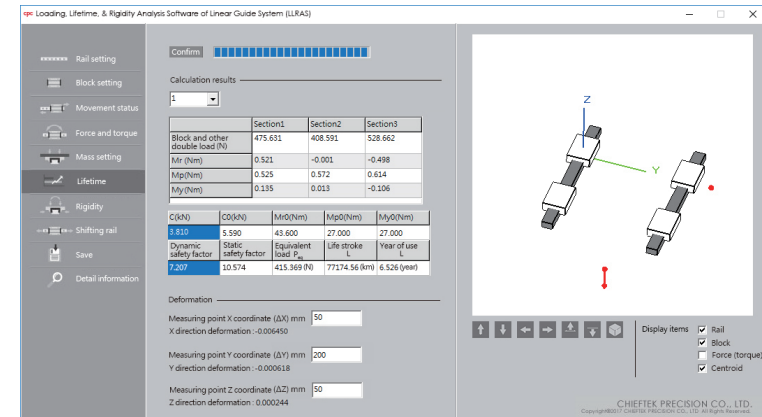

The calculation results are shown in the figure, and the information such as force and equivalent load P_{eq} , dynamic safety factor S_v , static safety factor S_p , and lifetime L (km/year) of each section can be obtained, and the deformation of any measured point can also be obtained.*

This program can be used to calculate the installation and dimension design of various linear slide rails under different load and movement conditions. The obtained information such as deformation amount, force distribution, and life span can help to provide appropriate and correct design recommendations.

* For the calculation of amount of deformation, only the rolling object is considered. For actual deformation the steel body of block must be considered as well. When the load > 20% C0, the actual deformation is 1.5 times larger than calculated deformation. When Load = C0, the actual deformation is 2~2.5 times of calculated deformation.

* If there is any information needed, please contact R&D department.

5. Set the quality position size

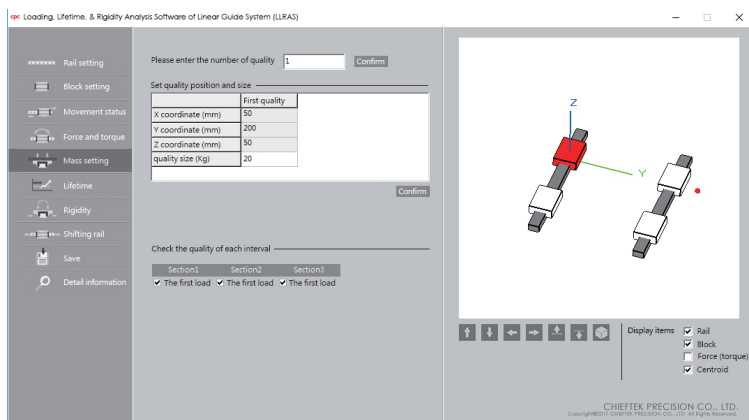

2. Technical Information

Application Example

Using the MR 15 MN VS block, the schematic diagram of the mechanism is as follows:

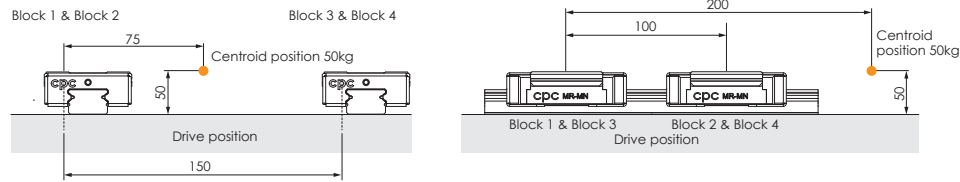

Motion status is as follows

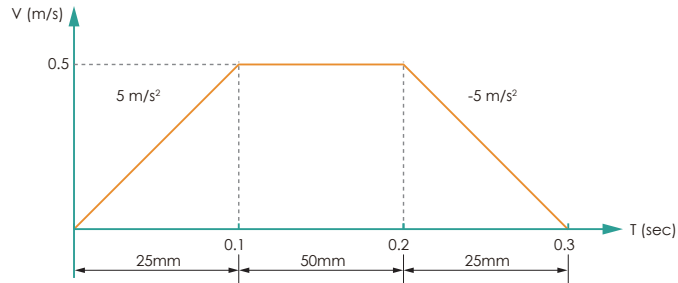

cpc

	Block 1	Block 2	Block 3	Block 4
At acceleration	261.2	536.1	261.2	536.1
At constant velocity	344.4	619.4	344.4	619.4
At deceleration	427.4	702.5	427.4	702.5
Average load	354.3	625.4	354.3	625.4

Traditional calculated results obtained by geometric distribution.

	Block 1	Block 2	Block 3	Block 4
At acceleration	183	432	183	432
At constant velocity	246	495	246	495
At deceleration	309	558	309	558
The maximum value of average load	499			

Results calculated by program

In this case, the calculated result of equivalent load is 25% higher than result obtained by traditional geometric distribution method, and the service life is about 2 times different.

If there is a demand for life and rigidity calculation, please fill in form of [Linear guide service life calculation and model selection] and contact cpc technical department.

3. Installation Illustration

Height and chamfer of reference edge

To avoid interference, the corner of the reference edge should have a chamfer. If not, please refer to the following table for the height of the reference edge corner and the height of the reference edge.

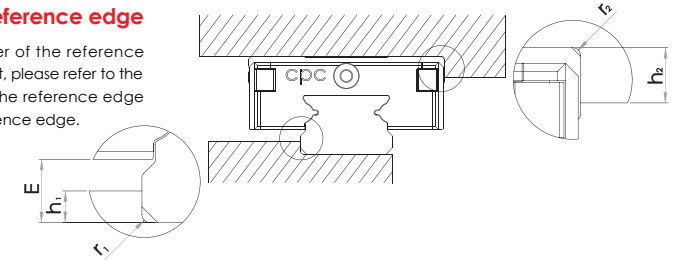

Height and chamfer of the reference surface

Dimension	h2	r2max	r1max	SS/ZZ		SU/ZU		EE/EZ		EU/UZ		SUE/ZUE	
				h1	E	h1	E	h1	E	h1	E	h1	E
3M	1.5	0.3	0.1	0.8	1	0.4	0.6	-	-	-	-	-	-
5M	1.9	0.3	0.2	1.1	1.3	0.8	1.0	0.8	1.1	-	-	0.7	1.0
7M	2.8	0.3	0.2	1.2	1.4	0.5	0.7	-	-	-	-	-	-
9M	3	0.3	0.2	1.8	2.1	1.2	1.4	1.3	1.7	1	1.4	1.1	1.5
12M	4	0.5	0.3	2.6	2.9	1.9	2.1	1.9	2.3	1.6	2	1.7	2.1
15M	4.5	0.5	0.3	3.6	3.9	2.7	2.9	2.8	3.2	2.5	2.9	2.4	2.9

Dimension	h2	r2max	r1max	SS/ZZ		SU/ZU		EE/EZ		EU/UZ		SUE/ZUE	
				h1	E	h1	E	h1	E	h1	E	h1	E
2WL	1.5	0.3	0.1	0.6	0.8	-	-	0.5	0.7	-	-	0.4	0.6
3W	1.7	0.3	0.1	0.4	0.6	0.4	0.6	-	-	-	-	-	-
5W	2	0.3	0.2	1.2	1.4	0.9	1.1	-	-	-	-	-	-
7W	2.8	0.3	0.2	1.7	1.9	1.3	1.5	1.2	1.5	-	-	1.1	1.4
9W	3	0.3	0.2	3	3.3	2.4	2.6	2.4	2.8	2.1	2.5	2.2	2.6
12W	4	0.5	0.3	3.5	3.7	2.5	2.7	2.9	3.3	2.4	2.8	2.4	2.8
15W	4.5	0.5	0.3	3.5	3.7	2.9	3.1	2.8	3.2	2.4	2.8	2.4	2.8

Screw tightening torque (Nm)

Screw grade 12.9 Alloy Steel Screw	ISO 3506-1 A2-70 Stainless Screw		
	Steel	Cast Iron	Non Iron Metal
M2	0.6	0.4	0.3
M2.5/M2.6	1.2	0.8	0.6
M3	1.8	1.3	1
M4	4	2.5	2

ISO 3506-1 A2-70 Stainless Screw	Cast Iron
M1.6	0.15
M2	0.3
M2.5/M2.6	0.6
M3	1.1
M4	2.5

The mounting surface

The mounting surface should be ground or fine milled to reach a surface roughness of Ra1.6 μm.

3. Installation Illustration

Geometric and positional accuracy of the mounting surface

Inaccurate mounting surfaces will affect the operational accuracy of the linear guide when the mounting surface height differential is greater than the values calculated by formulas (15), (16), and (17). The rating lifetime will also be shortened.

(15) $e1 \text{ (mm)} = b \text{ (mm)} \cdot f1 \cdot 10^{-4}$

(16) $e2 \text{ (mm)} = d \text{ (mm)} \cdot f2 \cdot 10^{-4}$

(17) $e3 \text{ (mm)} = f3 \cdot 10^{-3}$

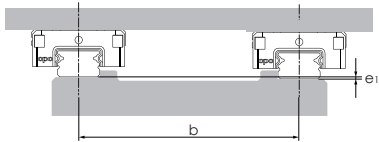

Reference edge

Rail: Both sides of the track rail can serve as the reference edge without any special marking.
Block: Reference edge is opposite to the groove marking side.

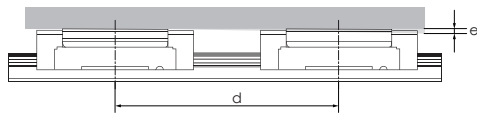
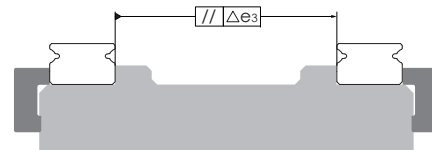

Dimension	V0 / VS			V1		
	f1	f2	f3	f1	f2	f3
3MN			3			2
5MN			3			2
7MN			5			4
9MN	4.5	3.0	7	3.1	2.1	5
12MN			9			6
15MN			12			8
3M L			3			2
5M L			3			2
7M L			5			4
9M L	4.3	2.0	6	2.9	1.3	4
12M L			8			6
15M L			11			7

Dimension	V0 / VS			V1		
	f1	f2	f3	f1	f2	f3
3WN			3			2
5WN			3			2
7WN			5			3
9WN	2.5	2.1	7	1.7	1.4	5
12WN			9			6
15WN			11			8
2W L			2			2
3W L			2			2
5W L			3			2
7W L		1.4	5	1.6	0.9	3
9W L			5			3
12W L			8			5
15W L			10			7

Rail installation

Diagram	Description	Feature
	<ul style="list-style-type: none"> No Straightening Not allowed 	No precision Low lateral bearing capacity
	<ul style="list-style-type: none"> Straightening by pin Not suggested 	Low precision Low lateral bearing capacity
	<ul style="list-style-type: none"> Straightening based on straight edge, calibrated by meter 	Low to mid precision Low lateral bearing capacity
	<ul style="list-style-type: none"> Place the rail on a supporting edge (Precision vise applied) 	High precision One side with high lateral bearing capacity
	<ul style="list-style-type: none"> With support edge and lateral mounting screw 	Very high precision High lateral bearing capacity on both sides.

Recommended precision measurement method

The working accuracy of linear guide is defined by the parallelism between block and rail (height, side). In practical application the linear accuracy is required, the measuring method is diverse, so we would suggest following measure to acquire the linear accuracy of linear guide.

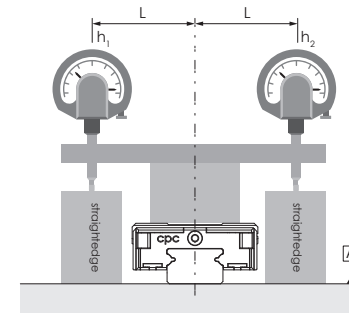

H The horizontal working accuracy $\parallel P \parallel +$ base plane flatness $\parallel Z \parallel A = |h_1 - h_2|_{\text{total length}}$
(above mentioned method can be used to exclude the skew error of rail on rail direction)

* When the error of flatness of base plane is 0, the value is the linear working accuracy of rail at the certain height
(Please refer to table of working precision page 07)

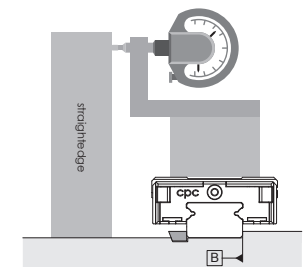

W_2 The horizontal working accuracy $\parallel P \parallel +$ the straightness of rail installation $\parallel B \parallel$

*When the error of the straightness of the rail is 0, the value is the horizontal working accuracy on the side.
(Please refer to table of working precision page 07)

4. Ordering Information

Length of Rail

Butt-jointing is required when lengths exceed Lmax.
(For more detailed information, please contact **cpc** for technical support.)

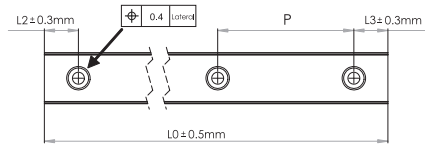

Model Code										Unit: mm																							
MR	U	15	M	N	K	EE	2	V1	P	-310L	-15	-15	II	J	Customization code																		
														Number of rails on the same moving axis		End hole pitch (mm)						Starting hole pitch (mm)		Rail length (mm)		Accuracy Grades: P (Precision), H (High), N (Normal)		Preload classes: V0: clearance VS: standard V1: light preload		Block quantity: Quantity of the runner block			
														SS: with end seal		ZZ: end seal + lubrication storage		SU: end seal + bottom seal		ZU: end seal + bottom seal + lubrication storage		EE: end seal + reinforcement plate		EZ: end seal + reinforcement plate + lubrication storage		EU: end seal + reinforcement plate + stainless bottom seal		UZ: end seal + reinforcement plate + stainless bottom seal + lubrication storage		SUE: end seal + bottom seal + reinforcement plate		ZUE: end seal + bottom seal + reinforcement plate + lubrication storage	
														Rail material : No Mark : standard rail K : carbon steel (Now available: size 9, 12, and 15.)						Block type: L: long N: standard		Rail type: M: standard W: wide		Rail dimension: The width of rail ex. : 2,3,5,7,9,12,15		Special Rail U: upward screwing rail No Mark: standard rail		Product Type: MR: Miniature Linear Guide					

Standard type	size						Unit: mm																																																		
Standard length of one rail	3M	5M	7M	9M	12M	15M	30	40	40	55	70	70	40	55	55	75	95	110	50	70	70	95	120	150	85	85	115	145	190	100	100	135	170	230	130	155	195	270	175	220	310	195	245	350	275	270	390	375	320	430	370	470	470	550	570	670	870
	Pitch	10	15	15	20	25	40																																																		
	L2, L3min.	3	3	3	4	4	4																																																		
	L2, L3max.	5	10	10	20	20	35																																																		
	L0 max.	300	1000	1000	1000	1000	1000																																																		

Wide type	size								Unit: mm																																																
Standard length of one rail	2W	3W	5W	7W	9W	12W	15W	30	40	50	50	50	70	110	40	55	70	80	80	110	150	50	70	90	110	110	150	190	110	140	140	190	230	130	170	170	230	270	150	200	200	270	310	170	260	260	310	430	290	290	390	550	320	470	670	550	790
	Pitch	10	15	20	30	30	40	40																																																	
	L2, L3min.	3	3	4	3	4	4	4																																																	
	L2, L3max.	5	10	15	25	25	35	35																																																	
	L0 max.	300	1000	1000	1000	1000	1000	1000																																																	

Customization Requirement

The meaning of suffix characters:

- J : slide rail connection
- G : customer designated lubricant
- I : with Inspection report

- R : special process for rail
- B : special processing for block
- S : special straightness requirements for rail

- C3 : Cap M3
- C4 : Cap M4
- MS : Metal Stopper on stainless steel Rail

J : slide rail connection

When the required length of rail exceeds the standard rail length, a butt-joint can be specified. The rail butt-joint indication is marked as illustrated below.



B : special processing for block

For special process requirements, please contact technical support.

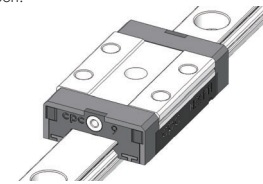

I : with Inspection report

Please contact technical support.

S : special straightness requirements for rail

The straightness of the linear guide rail is specially calibrated by precision fine grinding.

MS : Metal Stopper on Stainless Steel Rail

- To prevent the block from separating from the rail during transportation or installation; this may cause item damage or scattering.
- Perfect for rails installed on the vertical axis (Z-axis) to prevent gravity induced block separation from the rail.
- The stoppers and screws are made of stainless steel material with an anti-corrosion function.
- Strongly recommended NOT to use as a mechanical travel limiter or breaking system.

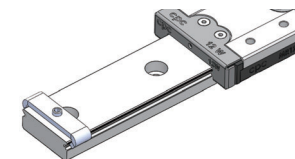

R : special process for rail

For special process requirements, please contact technical support.

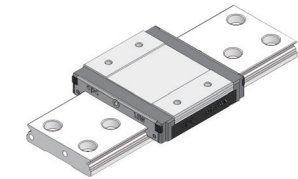

G : customer designated lubricant

According to application environment.

GN : no lubricant

GC : low dust generation

Suitable for clean room environments.

C3 CapM3 :

Applies to MR9M, MR12M, MR15M, MR7W & MR9W rails.

C4 CapM4 :

Applies to MR12W, MR15W rails.

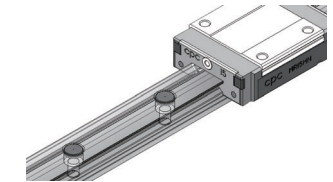

Dimension

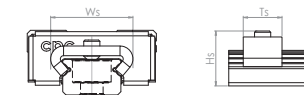

Rail Size	Ws max	Ts	Hs max
MR-7M	10	5	8
MR-9M	13	6	9
MR-12M	17	7	12
MR-15M	19	7	14
MR-7W	18	6	9
MR-9W	23	6	11
MR-12W	29	7	13
MR-15W	47	7	14

5. Dimensions and Specifications

5.1 MR-M SU Series (End seal , Bottom Seal)

MR-M ZU Series (End seal , Bottom Seal , Lubrication Storage)

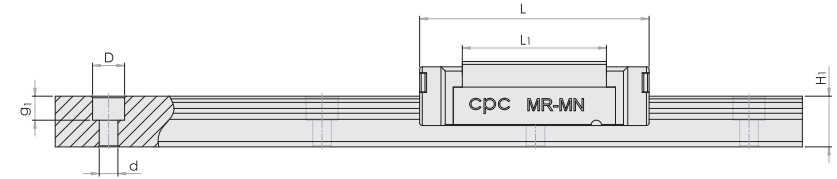
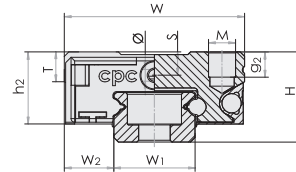

Model Code	Fabricate Dimensions		Rail Dimension(mm)				Block Dimension(mm)						Block Dimension(mm)				Load Capacities(N)		Static Moment(Nm)			Weight		Model Code
	H	W ₂	W ₁	H ₁	P	D x d x g ₁	W	L	L ₁	h ₂	P ₁	P ₂	M x g ₂	∅	S	T	C ₁₀₀₈ (dyn)	C ₀ (stat)	M _{r0}	M _{p0}	M _{y0}	Block(g)	Rail(g/m)	
MR 15ML SU/ZU	16	8.5	15	9.5	40	6x3.5x4.5	32	60.4	44	12.5	25	25	M3x5.5	1.8	3.3	4.3	5350	9080	70	63.3	63.3	90	930	MR 15ML SU/ZU
MR 15MN SU/ZU	16	8.5	15	9.5	40	6x3.5x4.5	32	43.5	27	12.5	20	25	M3x5.5	1.8	3.3	4.3	3810	5590	43.6	27	27	61	930	MR 15MN SU/ZU
MR 12ML SU/ZU	13	7.5	12	7.5	25	6x3.5x4.5	27	48	34	10.5	20	20	M3x3.5	1.3	3.2	4.3	3240	5630	34.9	30.2	30.2	51	602	MR 12ML SU/ZU
MR 12MN SU/ZU	13	7.5	12	7.5	25	6x3.5x4.5	27	35.7	22	10.4	15	20	M3x3.5	1.3	3.2	4.3	2308	3465	21.5	12.9	12.9	34	602	MR 12MN SU/ZU
MR 9ML SU/ZU	10	5.5	9	5.5	20	6x3.5x3.5	20	41.1	30.8	8.2	16	15	M3x3.0	1.3	2.2	3.3	2135	3880	18.2	12.4	12.4	28	301	MR 9ML SU/ZU
MR 9MN SU/ZU	10	5.5	9	5.5	20	6x3.5x3.5	20	30.9	20.5	8.3	10	15	M3x3.0	1.3	2.2	3.3	1570	2495	11.7	6.4	6.4	18	301	MR 9MN SU/ZU
MR 7ML SU/ZU	8	5	7	4.7	15	4.2x2.4x2.3	17	31.4	21.8	6.9	13	12	M2x2.5	1.1	1.6	2.8	1310	2440	9	7.7	7.7	14	215	MR 7ML SU/ZU
MR 7MN SU/ZU	8	5	7	4.7	15	4.2x2.4x2.3	17	24	14.3	7.0	8	12	M2x2.5	1.1	1.6	2.8	890	1440	5.2	3.3	3.3	8	215	MR 7MN SU/ZU
MR 5ML SU/ZU	6	3.5	5	3.5	15	3.5x2.4x1	12	19.9	13.5	4.9	7	-	M2.6x2.0	0.7	1.3	2	470	900	2.4	2.1	2.1	4	116	MR 5ML SU/ZU
MR 5MN SU/ZU	6	3.5	5	3.5	15	3.5x2.4x1	12	16.9	10	4.9	-	8	M2x1.5	0.7	1.3	2	335	550	1.7	1	1	3.5	116	MR 5MN SU/ZU
MRU 3ML SU [*] /ZU [*]	4	2.5	3	2.6	10	M1.6	8	16.1	11	3.5	5.5	-	M2x1.1	0.3	0.7	1.5	295	575	0.9	1.1	1.1	1.2	53	MRU 3ML SU [*] /ZU [*]
MRU 3MN SU [*] /ZU [*]	4	2.5	3	2.6	10	M1.6	8	11.8	6.7	3.5	3.5	-	M1.6x1.1	0.3	0.7	1.5	190	310	0.6	0.4	0.4	0.9	53	MRU 3MN SU [*] /ZU [*]

* Anticipated
Load capacities are calculated according to ISO 14728. To compare the rating life definition and the load capacities: C₅₀₈ = 1.26 x C₁₀₀₈

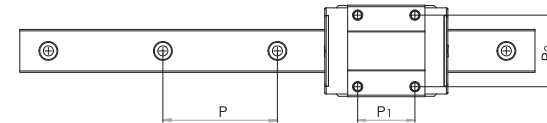
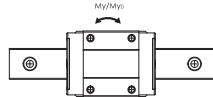
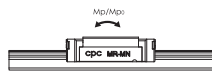
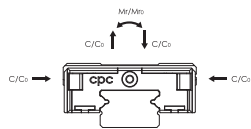

5. Dimensions and Specifications

5.2 MR-M SS Series (End seal)

MR-M ZZ Series (End seal , Lubrication Storage)

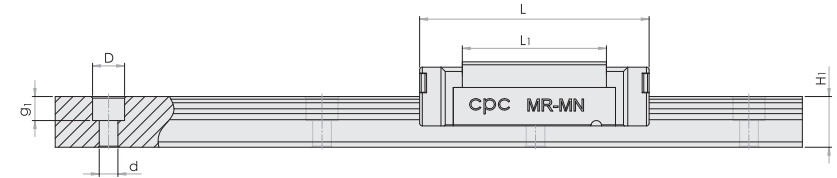
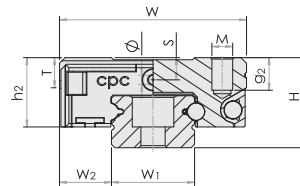

Model Code	Fabricate Dimensions		Rail Dimension(mm)				Block Dimension(mm)						Block Dimension(mm)				Load Capacities(N)		Static Moment(Nm)			Weight		Model Code
	H	W2	W1	H1	P	D x d x g1	W	L	L1	h2	P1	P2	M x g2	Ø	S	T	C1008 (dyn)	Co (stat)	Mr0	Mp0	My0	Block(g)	Rail(g/m)	
MR 15ML SS/ZZ	16	8.5	15	9.5	40	6x3.5x4.5	32	60.2	44	12.2	25	25	M3x5.5	1.8	3.3	4.3	5350	9080	70	63.3	63.3	90	930	MR 15ML SS/ZZ
MR 15MN SS/ZZ	16	8.5	15	9.5	40	6x3.5x4.5	32	43.4	27	12.2	20	25	M3x5.5	1.8	3.3	4.3	3810	5590	43.6	27	27	61	930	MR 15MN SS/ZZ
MR 12ML SS/ZZ	13	7.5	12	7.5	25	6x3.5x4.5	27	47.8	34	10.2	20	20	M3x3.5	1.3	3.2	4.3	3240	5630	34.9	30.2	30.2	51	602	MR 12ML SS/ZZ
MR 12MN SS/ZZ	13	7.5	12	7.5	25	6x3.5x4.5	27	35.8	22	10.1	15	20	M3x3.5	1.3	3.2	4.3	2308	3465	21.5	12.9	12.9	34	602	MR 12MN SS/ZZ
MR 9ML SS/ZZ	10	5.5	9	5.5	20	6x3.5x3.5	20	41.1	30.8	8	16	15	M3x3.0	1.3	2.2	3.3	2135	3880	18.2	12.4	12.4	28	301	MR 9ML SS/ZZ
MR 9MN SS/ZZ	10	5.5	9	5.5	20	6x3.5x3.5	20	30.9	20.5	7.9	10	15	M3x3.0	1.3	2.2	3.3	1570	2495	11.7	6.4	6.4	18	301	MR 9MN SS/ZZ
MR 7ML SS/ZZ	8	5	7	4.7	15	4.2x2.4x2.3	17	31.5	21.8	6.7	13	12	M2x2.5	1.1	1.6	2.8	1310	2440	9	7.7	7.7	14	215	MR 7ML SS/ZZ
MR 7MN SS/ZZ	8	5	7	4.7	15	4.2x2.4x2.3	17	24.1	14.3	6.6	8	12	M2x2.5	1.1	1.6	2.8	890	1440	5.2	3.3	3.3	8	215	MR 7MN SS/ZZ
MR 5ML SS/ZZ	6	3.5	5	3.5	15	3.5x2.4x1	12	19.7	13.5	4.6	7	-	M2.6x2.0	0.7	1.3	2	470	900	2.4	2.1	2.1	4	116	MR 5ML SS/ZZ
MR 5MN SS/ZZ	6	3.5	5	3.5	15	3.5x2.4x1	12	16.3	10	4.7	-	8	M2x1.5	0.7	1.3	2	335	550	1.7	1	1	3.5	116	MR 5MN SS/ZZ
MRU 3ML SS	4	2.5	3	2.6	10	M1.6	8	16.1	11	3.2	5.5	-	M2x1.1	0.3	0.7	1.5	295	575	0.9	1.1	1.1	1.2	53	MRU 3ML SS
MRU 3MN SS	4	2.5	3	2.6	10	M1.6	8	11.9	6.7	3.2	3.5	-	M1.6x1.1	0.3	0.7	1.5	190	310	0.6	0.4	0.4	0.9	53	MRU 3MN SS

Load capacities are calculated according to ISO 14728. To compare the rating life definition and the load capacities: $C_{508} = 1.26 \times C_{1008}$



5. Dimensions and Specifications

5.3 MR-M SUE Series (End seal, Bottom Seal, Reinforcement Plate)

MR-M ZUE Series (End seal, Bottom Seal , Reinforcement Plate , Lubrication Storage)

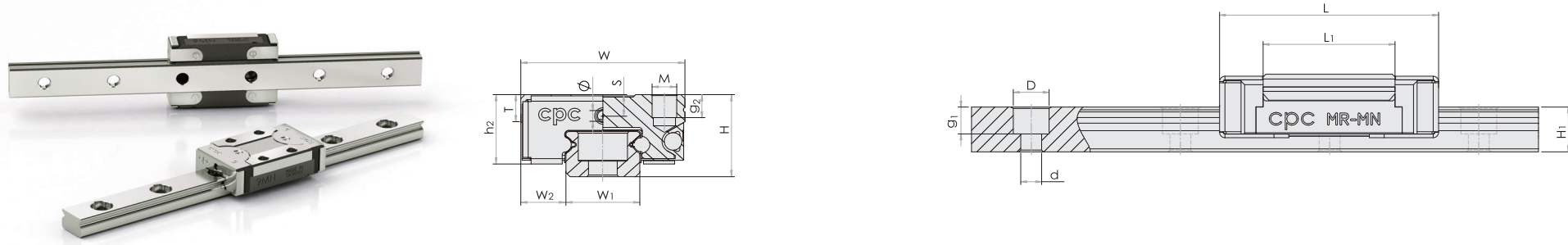

Model Code	Fabricate Dimensions		Rail Dimension(mm)				Block Dimension(mm)						Block Dimension(mm)				Load Capacities(N)		Static Moment(Nm)			Weight		Model Code
	H	W2	W1	H1	P	D x d x g1	W	L	L1	h2	P1	P2	M x g2	Ø	S	T	C1008 (dyn)	Co (stat)	Mr0	Mp0	My0	Block(g)	Rail(g/m)	
MR 15ML SUE/ZUE	16	8.5	15	9.5	40	6x3.5x4.5	32	62	44	13.1	25	25	M3x5.5	1.8	3.3	4.3	5350	9080	70	63.3	63.3	90	930	MR 15ML SUE/ZUE
MR 15MN SUE/ZUE	16	8.5	15	9.5	40	6x3.5x4.5	32	45.1	27	13.3	20	25	M3x5.5	1.8	3.3	4.3	3810	5590	43.6	27	27	61	930	MR 15MN SUE/ZUE
MR 12ML SUE/ZUE	13	7.5	12	7.5	25	6x3.5x4.5	27	49	34	11.1	20	20	M3x3.5	1.3	3.2	4.3	3240	5630	34.9	30.2	30.2	51	602	MR 12ML SUE/ZUE
MR 12MN SUE/ZUE	13	7.5	12	7.5	25	6x3.5x4.5	27	37	22	11.2	15	20	M3x3.5	1.3	3.2	4.3	2308	3465	21.5	12.9	12.9	34	602	MR 12MN SUE/ZUE
MR 9ML SUE/ZUE	10	5.5	9	5.5	20	6x3.5x3.5	20	42	30.8	8.6	16	15	M3x3.0	1.3	2.2	3.3	2135	3880	18.2	12.4	12.4	28	301	MR 9ML SUE/ZUE
MR 9MN SUE/ZUE	10	5.5	9	5.5	20	6x3.5x3.5	20	31.9	20.5	8.7	10	15	M3x3.0	1.3	2.2	3.3	1570	2495	11.7	6.4	6.4	18	301	MR 9MN SUE/ZUE
MR 5ML SUE/ZUE	6	3.5	5	3.5	15	3.5x2.4x1	12	20.3	13.5	5.1	7	-	M2.6x2.0	0.7	1.3	2	470	900	2.4	2.1	2.1	4	116	MR 5ML SUE/ZUE
MR 5MN SUE/ZUE	6	3.5	5	3.5	15	3.5x2.4x1	12	16.8	10	5	-	8	M2x1.5	0.7	1.3	2	335	550	1.7	1	1	3.5	116	MR 5MN SUE/ZUE

Load capacities are calculated according to ISO 14728. To compare the rating life definition and the load capacities: $C_{508} = 1.26 \times C_{1008}$

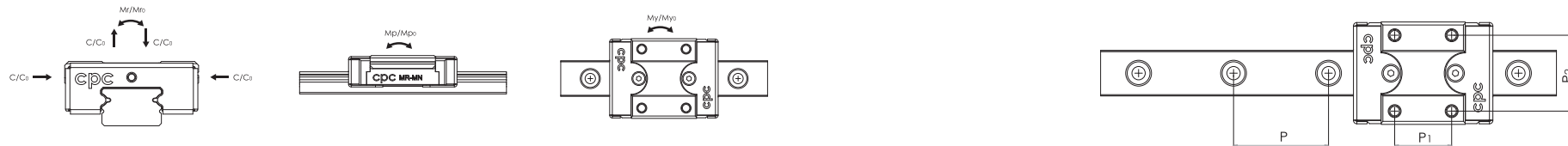

5. Dimensions and Specifications

5.4 MR-M EE Series (End seal, Reinforcement Plate)

MR-M EZ Series (End seal , Reinforcement Plate , Lubrication Storage)

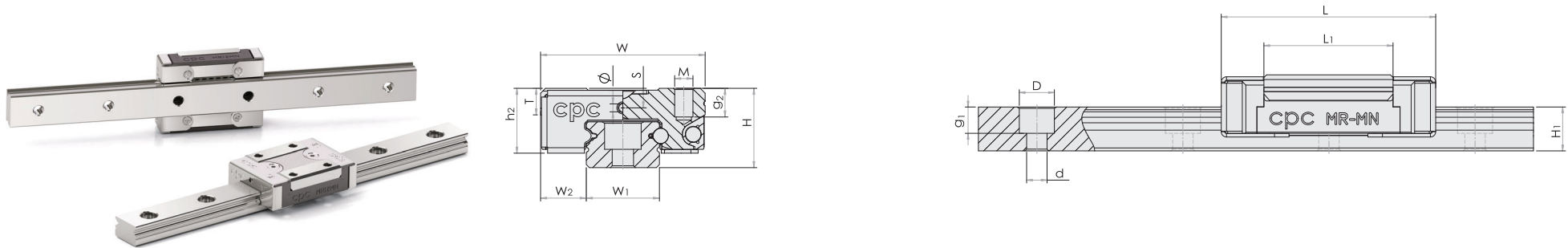

Model Code	Fabricate Dimensions		Rail Dimension(mm)					Block Dimension(mm)					Block Dimension(mm)				Load Capacities(N)		Static Moment(Nm)			Weight		Model Code
	H	W ₂	W ₁	H ₁	P	D x d x g ₁	W	L	L ₁	h ₂	P ₁	P ₂	M x g ₂	∅	S	T	C ₁₀₀₈ (dyn)	C ₀ (stat)	M _{r0}	M _{p0}	M _{y0}	Block(g)	Rail(g/m)	
MR 15ML EE/EZ	16	8.5	15	9.5	40	6x3.5x4.5	32	62.1	44	13.2	25	25	M3x5.5	1.8	3.3	4.3	5350	9080	70	63.3	63.3	90	930	MR 15ML EE/EZ
MR 15MN EE/EZ	16	8.5	15	9.5	40	6x3.5x4.5	32	45.2	27	13.2	20	25	M3x5.5	1.8	3.3	4.3	3810	5590	43.6	27	27	61	930	MR 15MN EE/EZ
MR 12ML EE/EZ	13	7.5	12	7.5	25	6x3.5x4.5	27	49	34	10.9	20	20	M3x3.5	1.3	3.2	4.3	3240	5630	34.9	30.2	30.2	51	602	MR 12ML EE/EZ
MR 12MN EE/EZ	13	7.5	12	7.5	25	6x3.5x4.5	27	37	22	10.9	15	20	M3x3.5	1.3	3.2	4.3	2308	3465	21.5	12.9	12.9	34	602	MR 12MN EE/EZ
MR 9ML EE/EZ	10	5.5	9	5.5	20	6x3.5x3.5	20	42	30.8	8.4	16	15	M3x3.0	1.3	2.2	3.3	2135	3880	18.2	12.4	12.4	28	301	MR 9ML EE/EZ
MR 9MN EE/EZ	10	5.5	9	5.5	20	6x3.5x3.5	20	31.7	20.5	8.4	10	15	M3x3.0	1.3	2.2	3.3	1570	2495	11.7	6.4	6.4	18	301	MR 9MN EE/EZ
MR 5ML EE/EZ	6	3.5	5	3.5	15	3.5x2.4x1	12	20.4	13.5	5	7	-	M2.6x2.0	0.7	1.3	2	470	900	2.4	2.1	2.1	4	116	MR 5ML EE/EZ
MR 5MN EE/EZ	6	3.5	5	3.5	15	3.5x2.4x1	12	16.9	10	5	-	8	M2x1.5	0.7	1.3	2	335	550	1.7	1	1	3.5	116	MR 5MN EE/EZ

* Anticipated

Load capacities are calculated according to ISO 14728. To compare the rating life definition and the load capacities: C₅₀₈ = 1.26 x C₁₀₀₈

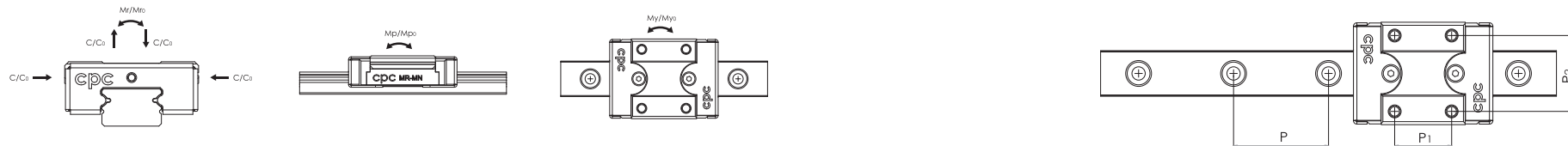

5. Dimensions and Specifications

5.5 MR-M EU Series (End seal , Reinforcement Plate , Stainless Bottom Seal)

MR-M UZ Series (End seal , Reinforcement Plate , Stainless Bottom Seal ,
Lubrication Storage)

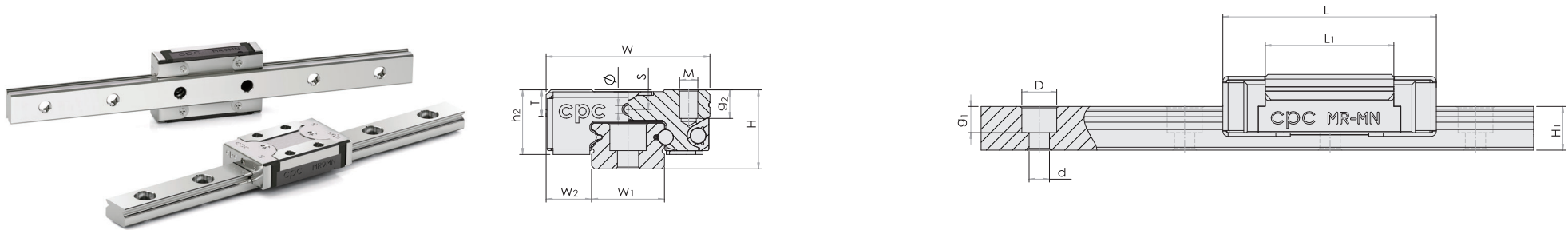

Model Code	Fabricate Dimensions		Rail Dimension(mm)				Block Dimension(mm)						Block Dimension(mm)				Load Capacities(N)		Static Moment(Nm)			Weight		Model Code
	H	W2	W1	H1	P	D x d x g 1	W	L	L1	h2	P1	P2	M x g2	Ø	S	T	C1008 (dyn)	Ca (stat)	Mr0	Mp0	My0	Block(g)	Rail(g/m)	
MR 15ML EU/UZ	16	8.5	15	9.5	40	6x3.5x4.5	32	62.1	44	13.2	25	25	M3x5.5	1.8	3.3	4.3	5350	9080	70	63.3	63.3	90	930	MR 15ML EU/UZ
MR 15MN EU/UZ	16	8.5	15	9.5	40	6x3.5x4.5	32	45.1	27	13.1	20	25	M3x5.5	1.8	3.3	4.3	3810	5590	43.6	27	27	61	930	MR 15MN EU/UZ
MR 12ML EU/UZ	13	7.5	12	7.5	25	6x3.5x4.5	27	49	34	11	20	20	M3x3.5	1.3	3.2	4.3	3240	5630	34.9	30.2	30.2	51	602	MR 12ML EU/UZ
MR 12MN EU/UZ	13	7.5	12	7.5	25	6x3.5x4.5	27	37	22	11	15	20	M3x3.5	1.3	3.2	4.3	2308	3465	21.5	12.9	12.9	34	602	MR 12MN EU/UZ
MR 9ML EU/UZ	10	5.5	9	5.5	20	6x3.5x3.5	20	42	30.8	8.5	16	15	M3x3.0	1.3	2.2	3.3	2135	3880	18.2	12.4	12.4	28	301	MR 9ML EU/UZ
MR 9MN EU/UZ	10	5.5	9	5.5	20	6x3.5x3.5	20	31.9	20.5	8.5	10	15	M3x3.0	1.3	2.2	3.3	1570	2495	11.7	6.4	6.4	18	301	MR 9MN EU/UZ

Load capacities are calculated according to ISO 14728. To compare the rating life definition and the load capacities: $C_{508} = 1.26 \times C_{1008}$

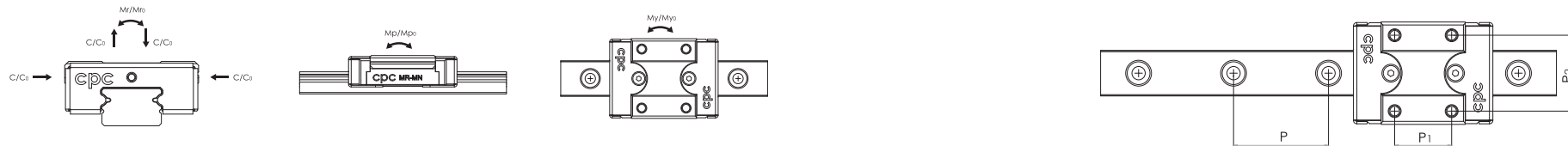

5. Dimensions and Specifications

5.6 MR-W SU Series (End seal , Bottom Seal)

MR-W ZU Series (End seal , Bottom Seal , Lubrication Storage)

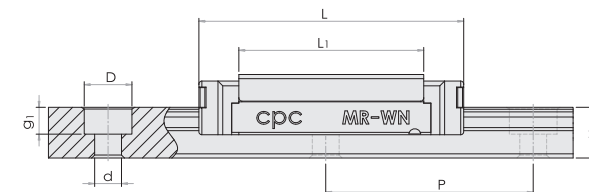
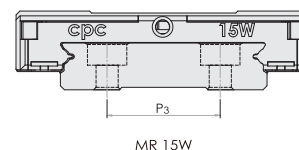
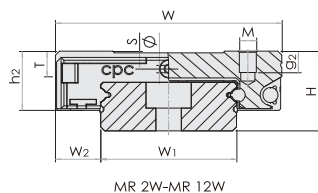

Model Code	Fabricate Dimensions		Rail Dimension(mm)				Block Dimension(mm)						Block Dimension(mm)				Load Capacities(N)		Static Moment(Nm)			Weight		Model Code	
	H	W ₂	W ₁	H ₁	P	P ₃	D x d x g ₁	W	L	L ₁	h ₂	P ₁	P ₂	M x g ₂	∅	S	T	C _{100B} (dyn)	C ₀ (stat)	M _{r0}	M _{p0}	M _{y0}	Block(g)		Rail(g/m)
MR 15WL SU/ZU	16	9	42	9.5	40	23	8x4.5x4.5	60	74.8	57.6	12.6	35	45	M4x4.5	1.8	3.3	4.5	6725	12580	257.6	93.1	93.1	200	2818	MR 15WL SU/ZU
MR 15WN SU/ZU	16	9	42	9.5	40	23	8x4.5x4.5	60	55.7	38.5	12.6	20	45	M4x4.5	1.8	3.3	4.5	5065	8385	171.1	45.7	45.7	137	2818	MR 15WN SU/ZU
MR 12WL SU/ZU	14	8	24	8.5	40	-	8x4.5x4.5	40	59.8	46	10.7	28	28	M3x3.5	1.3	3.1	4.5	4070	7800	95.6	56.4	56.4	93	1472	MR 12WL SU/ZU
MR 12WN SU/ZU	14	8	24	8.5	40	-	8x4.5x4.5	40	44.7	31	10.5	15	28	M3x3.5	1.3	3.1	4.5	3065	5200	63.7	26.3	26.3	65	1472	MR 12WN SU/ZU
MR 9WL SU/ZU	12	6	18	7.3	30	-	6x3.5x4.5	30	51	39.5	9	24	23	M3x3	1.3	2.6	4	2550	4990	45.9	26.7	26.7	51	940	MR 9WL SU/ZU
MR 9WN SU/ZU	12	6	18	7.3	30	-	6x3.5x4.5	30	39.4	27.9	9.1	12	21	M3x3	1.3	2.6	4	2030	3605	33.2	13.7	13.7	37	940	MR 9WN SU/ZU
MR 7WL SU/ZU*	9	5.5	14	5.2	30	-	6x3.5x3.5	25	40.9	30.1	7.4	19	19	M3x3	1.1	1.9	3.2	1570	3140	22.65	14.9	14.9	27	516	MR 7WL SU/ZU*
MR 7WN SU/ZU	9	5.5	14	5.2	30	-	6x3.5x3.5	25	32	21.2	7.3	10	19	M3x3	1.1	1.9	3.2	1180	2095	15	7.3	7.3	19	516	MR 7WN SU/ZU
MR 5WL SU/ZU	6.5	3.5	10	4	20	-	5.5x3x1.6	17	27.5	21.2	5.5	11	13	M2.5x1.5	0.9	1.2	2.3	615	1315	6.8	4.1	4.1	8	280	MR 5WL SU/ZU
MR 5WLC SU/ZU	6.5	3.5	10	4	20	-	5.5x3x1.6	17	27.5	21.2	5.5	11	13	M3/M2.5x1.5	0.9	1.2	2.3	615	1315	6.8	4.1	4.1	8	280	MR 5WLC SU/ZU
MR 5WN SU/ZU	6.5	3.5	10	4	20	-	5.5x3x1.6	17	21.4	15.1	5.4	6.5	13	M2.5x1.5	0.9	1.2	2.3	475	900	4.6	2.2	2.2	6	280	MR 5WN SU/ZU
MR 5WNC SU/ZU	6.5	3.5	10	4	20	-	5.5x3x1.6	17	21.4	15.1	5.4	6.5	13	M3/M2.5x1.5	0.9	1.2	2.3	475	900	4.6	2.2	2.2	6	280	MR 5WNC SU/ZU
MR 3WL SU/ZU*	4.5	3	6	2.7	15	-	4x2.4x1.5	12	20.3	15.1	4	8	-	M2x1.4	0.3	0.8	1.8	370	800	2.5	1.9	1.9	3.4	105	MR 3WL SU/ZU*
MR 3WN SU/ZU*	4.5	3	6	2.7	15	-	4x2.4x1.5	12	15.4	10	3.9	4.5	-	M2x1.4	0.3	0.8	1.8	280	530	1.6	0.9	0.9	3.4	105	MR 3WN SU/ZU*
MR 2WL SU*/ZU*	4	3	4	2.6	10	-	2.8x1.8x1.0	10	17	11.9	3.1	6.5	-	M2x1.3	-	-	1.3	310	625	1.6	1.2	1.2	3.0	69	MR 2WL SU*/ZU*

* Anticipated

Load capacities are calculated according to ISO 14728. To compare the rating life definition and the load capacities: C_{50B} = 1.26 x C_{100B}

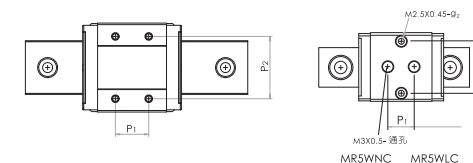
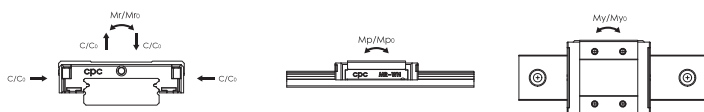

5. Dimensions and Specifications

5.7 MR-W SS Series (End seal)

MR-W ZZ Series (End seal , Lubrication Storage)

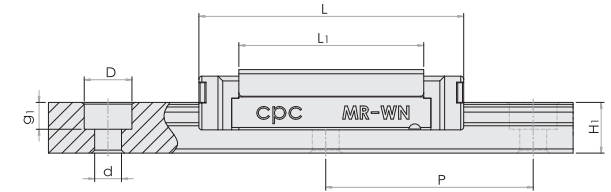
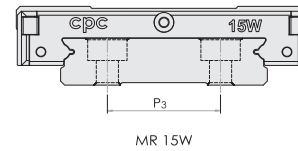
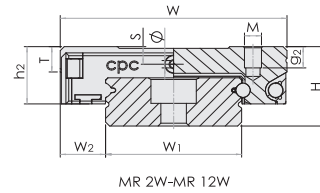

Model Code	Fabricate Dimensions		Rail Dimension(mm)				Block Dimension(mm)						Block Dimension(mm)				Load Capacities(N)		Static Moment(Nm)			Weight		Model Code	
	H	W2	W1	H1	P	P3	Dx dx g1	W	L	L1	h2	P1	P2	Mxg2	∅	S	T	C1008 (dyn)	Co (stat)	Mro	Mpo	Myo	Block(g)		Rail(g/m)
MR 15WL SS/ZZ	16	9	42	9.5	40	23	8x4.5x4.5	60	74.9	57.6	12.3	35	45	M4x4.5	1.9	3.3	4.5	6725	12580	257.6	93.1	93.1	200	2818	MR 15WL SS/ZZ
MR 15WN SS/ZZ	16	9	42	9.5	40	23	8x4.5x4.5	60	55.7	38.5	12.3	20	45	M4x4.5	1.9	3.3	4.5	5065	8385	171.1	45.7	45.7	137	2818	MR 15WN SS/ZZ
MR 12WL SS/ZZ	14	8	24	8.5	40	-	8x4.5x4.5	40	60	46	10.3	28	28	M3x3.5	1.3	3.1	4.5	4070	7800	95.6	56.4	56.4	93	1472	MR 12WL SS/ZZ
MR 12WN SS/ZZ	14	8	24	8.5	40	-	8x4.5x4.5	40	44.9	31.1	10.3	15	28	M3x3.5	1.3	3.1	4.5	3065	5200	63.7	26.3	26.3	65	1472	MR 12WN SS/ZZ
MR 9WL SS/ZZ	12	6	18	7.3	30	-	6x3.5x4.5	30	50.8	39.5	8.8	24	23	M3x3	1.3	2.6	4	2550	4990	45.9	26.7	26.7	51	940	MR 9WL SS/ZZ
MR 9WN SS/ZZ	12	6	18	7.3	30	-	6x3.5x4.5	30	39.4	27.9	8.9	12	21	M3x3	1.3	2.6	4	2030	3605	33.2	13.7	13.7	37	940	MR 9WN SS/ZZ
MR 7WL SS/ZZ	9	5.5	14	5.2	30	-	6x3.5x3.5	25	40.8	30.1	7.1	19	19	M3x3	1.1	1.9	3.2	1570	3140	22.65	14.9	14.9	27	516	MR 7WL SS/ZZ
MR 7WN SS/ZZ	9	5.5	14	5.2	30	-	6x3.5x3.5	25	31.9	21.2	7.1	10	19	M3x3	1.1	1.9	3.2	1180	2095	15	7.3	7.3	19	516	MR 7WN SS/ZZ
MR 5WL SS	6.5	3.5	10	4	20	-	5.5x3x1.6	17	27.6	21.2	5.1	11	13	M2.5x1.5	0.9	1.2	2.3	615	1315	6.8	4.1	4.1	8	280	MR 5WL SS
MR 5WLC SS	6.5	3.5	10	4	20	-	5.5x3x1.6	17	27.6	21.2	5.1	11	13	M3/M2.5x1.5	0.9	1.2	2.3	615	1315	6.8	4.1	4.1	8	280	MR 5WLC SS
MR 5WN SS	6.5	3.5	10	4	20	-	5.5x3x1.6	17	21.4	15.1	5.1	6.5	13	M2.5x1.5	0.9	1.2	2.3	475	900	4.6	2.2	2.2	6	280	MR 5WN SS
MR 5WNC SS	6.5	3.5	10	4	20	-	5.5x3x1.6	17	21.4	15.1	5.1	6.5	13	M3/M2.5x1.5	0.9	1.2	2.3	475	900	4.6	2.2	2.2	6	280	MR 5WNC SS
MR 3WN SS	4.5	3	6	2.7	15	-	4x2.4x1.5	12	15.3	10	3.9	4.5	-	M2x1.4	0.3	0.8	1.8	280	530	1.6	0.9	0.9	3.4	105	MR 3WN SS
MR 2WL SS/ZZ*	4	3	4	2.6	10	-	2.8x1.8x1.0	10	17.4	11.9	3.2	6.5	-	M2x1.3	-	-	1.3	310	625	1.6	1.2	1.2	3.0	69	MR 2WL SS/ZZ*

* Anticipated
 Load capacities are calculated according to ISO 14728. To compare the rating life definition and the load capacities: C508 = 1.26 x C1008

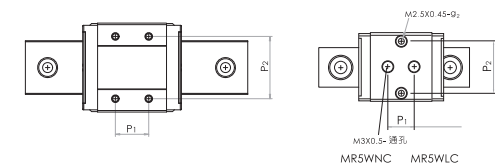
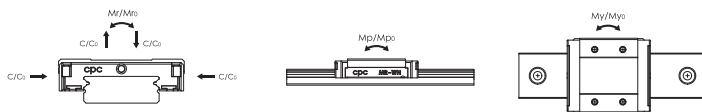

5. Dimensions and Specifications

5.8 MR-W SUE Series (End seal , Bottom Seal , Reinforcement Plate)

MR-W ZUE Series (End seal , Bottom Seal , Reinforcement Plate , Lubrication Storage)

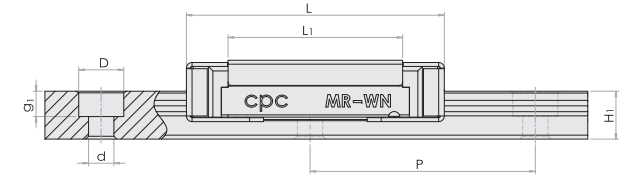
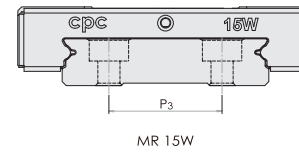
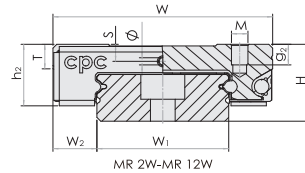
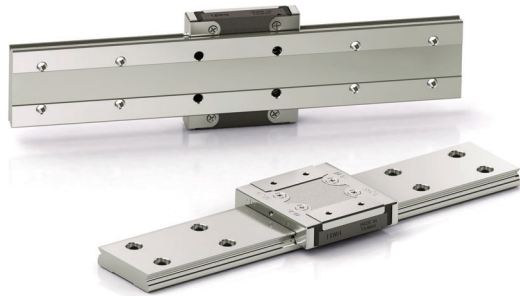

Model Code	Fabricate Dimensions		Rail Dimension(mm)				Block Dimension(mm)						Block Dimension(mm)				Load Capacities(N)		Static Moment(Nm)			Weight		Model Code	
	H	W ₂	W ₁	H ₁	P	P ₃	D x d x g ₁	W	L	L ₁	h ₂	P ₁	P ₂	M x g ₂	Ø	S	T	C ₁₀₀₈ (dyn)	C ₀ (stat)	M _{r0}	M _{p0}	M _{y0}	Block(g)		Rail(g/m)
MR 15WL SUE/ZUE	16	9	42	9.5	40	23	8x4.5x4.5	60	76.5	57.6	13.2	35	45	M4x4.5	1.8	3.3	4.5	6725	12580	257.6	93.1	93.1	203	2818	MR 15WL SUE/ZUE
MR 15WN SUE/ZUE	16	9	42	9.5	40	23	8x4.5x4.5	60	57.5	38.5	13.2	20	45	M4x4.5	1.8	3.3	4.5	5065	8385	171.1	45.7	45.7	140	2818	MR 15WN SUE/ZUE
MR 12WL SUE/ZUE	14	8	24	8.5	40	-	8x4.5x4.5	40	61.1	46	11.4	28	28	M3x3.5	1.3	3.1	4.5	4070	7800	95.6	56.4	56.4	96	1472	MR 12WL SUE/ZUE
MR 12WN SUE/ZUE	14	8	24	8.5	40	-	8x4.5x4.5	40	46.1	31	11.5	15	28	M3x3.5	1.3	3.1	4.5	3065	5200	63.7	26.3	26.3	68	1472	MR 12WN SUE/ZUE
MR 9WL SUE/ZUE	12	6	18	7.3	30	-	6x3.5x4.5	30	51.9	39.5	9.6	24	23	M3x3	1.3	2.6	4	2550	4990	45.9	26.7	26.7	51	940	MR 9WL SUE/ZUE
MR 9WN SUE/ZUE	12	6	18	7.3	30	-	6x3.5x4.5	30	40.4	27.9	9.5	12	21	M3x3	1.3	2.6	4	2030	3605	33.2	13.7	13.7	37	940	MR 9WN SUE/ZUE
MR 7WL SUE/ZUE	9	5.5	14	5.2	30	-	6x3.5x3.5	25	41.6	30.1	7.9	19	19	M3x3	1.1	1.9	3.2	1570	3140	22.65	14.9	14.9	27	516	MR 7WL SUE/ZUE
MR 7WN SUE/ZUE	9	5.5	14	5.2	30	-	6x3.5x3.5	25	32.8	21.2	7.9	10	19	M3x3	1.1	1.9	3.2	1180	2095	15	7.3	7.3	19	516	MR 7WN SUE/ZUE
MR 2WL SUE*/ZUE*	4	3	4	3	10	-	2.8x1.8x1.0	10	17.5	11.9	3.4	6.5	-	M2x1.3	-	-	1.3	310	625	1.6	1.2	1.2	3.0	69	MR 2WL SUE*/ZUE*

* Anticipated
Load capacities are calculated according to ISO 14728. To compare the rating life definition and the load capacities: C₅₀₈ = 1.26 x C₁₀₀₈

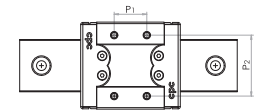
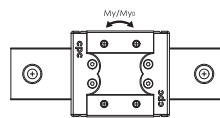
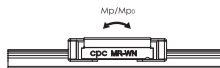
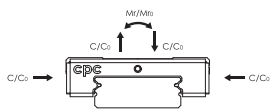

5. Dimensions and Specifications

5.9 MR-W EE Series (End seal, Reinforcement Plate)

MR-W EZ Series (End seal , Reinforcement Plate , Lubrication Storage)

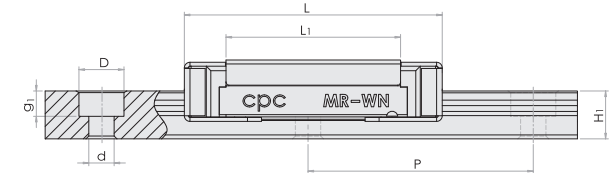
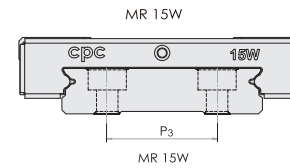
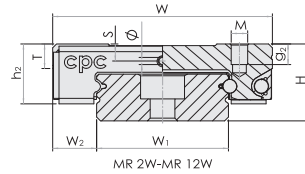

Model Code	Fabricate Dimensions		Rail Dimension(mm)				Block Dimension(mm)						Block Dimension(mm)				Load Capacities(N)		Static Moment(Nm)			Weight		Model Code	
	H	W2	W1	H1	P	P3	D x d x g1	W	L	Li	h2	P1	P2	M x g2	Ø	S	T	C1008 (dyn)	Co (stat)	Mr0	Mp0	My0	Block(g)		Rail(g/m)
MR 15WL EE/EZ	16	9	42	9.5	40	23	8x4.5x4.5	60	76.6	57.6	13	35	45	M4x4.5	1.8	3.3	4.5	6725	12580	257.6	93.1	93.1	203	2818	MR 15WL EE/EZ
MR 15WN EE/EZ	16	9	42	9.5	40	23	8x4.5x4.5	60	57.4	38.5	12.9	20	45	M4x4.5	1.8	3.3	4.5	5065	8385	171.1	45.7	45.7	140	2818	MR 15WN EE/EZ
MR 12WL EE/EZ	14	8	24	8.5	40	-	8x4.5x4.5	40	61.3	46	11.2	28	28	M3x3.5	1.3	3.1	4.5	4070	7800	95.6	56.4	56.4	96	1472	MR 12WL EE/EZ
MR 12WN EE/EZ	14	8	24	8.5	40	-	8x4.5x4.5	40	46.2	31	11.2	15	28	M3x3.5	1.3	3.1	4.5	3065	5200	63.7	26.3	26.3	68	1472	MR 12WN EE/EZ
MR 9WL EE/EZ	12	6	18	7.3	30	-	6x3.5x4.5	30	51.9	39.5	9.4	24	23	M3x3	1.3	2.6	4	2550	4990	45.9	26.7	26.7	51	940	MR 9WL EE/EZ
MR 9WN EE/EZ	12	6	18	7.3	30	-	6x3.5x4.5	30	40.4	27.9	9.5	12	21	M3x3	1.3	2.6	4	2030	3605	33.2	13.7	13.7	37	940	MR 9WN EE/EZ
MR 7WL EE/EZ	9	5.5	14	5.2	30	-	6x3.5x3.5	25	41.7	30.1	7.8	19	19	M3x3	1.1	1.9	3.2	1570	3140	22.65	14.9	14.9	27	516	MR 7WL EE/EZ
MR 7WN EE/EZ	9	5.5	14	5.2	30	-	6x3.5x3.5	25	32.8	21.2	7.6	10	19	M3x3	1.1	1.9	3.2	1180	2095	15	7.3	7.3	19	516	MR 7WN EE/EZ
MR 2WL EE/EZ*	4	3	4	3	10	-	2.8x1.8x1.0	10	17.9	11.9	3.5	6.5	-	M2x1.3	-	-	1.3	310	625	1.6	1.2	1.2	3.0	69	MR 2WL EE/EZ*

* Anticipated
Load capacities are calculated according to ISO 14728. To compare the rating life definition and the load capacities: C₅₀₈ = 1.26 x C₁₀₀₈

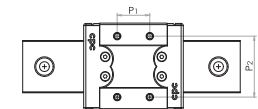
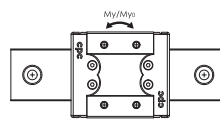
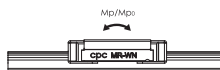
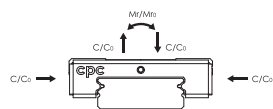

5. Dimensions and Specifications

5.10 MR-W EU Series (End seal , Reinforcement Plate , Stainless Bottom Seal)

MR-W UZ Series (End seal , Reinforcement Plate , Stainless Bottom Seal ,
Lubrication Storage)

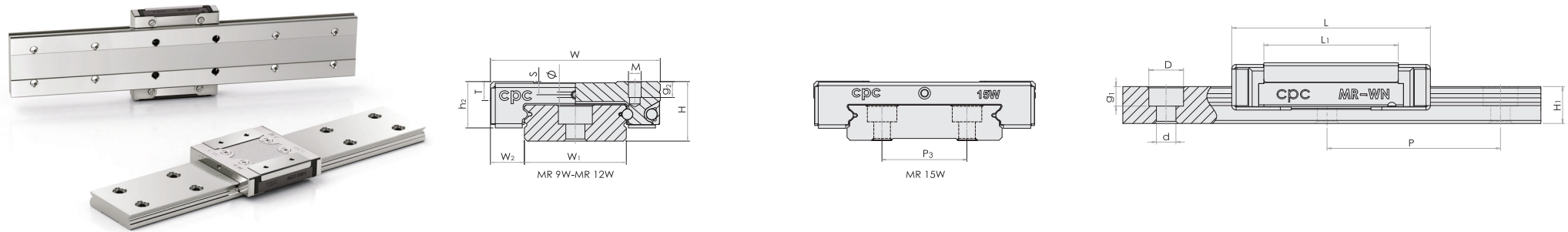

Model Code	Fabricate Dimensions		Rail Dimension(mm)				Block Dimension(mm)						Block Dimension(mm)				Load Capacities(N)		Static Moment(Nm)			Weight		Model Code	
	H	W ₂	W ₁	H ₁	P	P ₃	D x d x g ₁	W	L	L ₁	h ₂	P ₁	P ₂	M x g ₂	∅	S	T	C ₁₀₀₈ (dyn)	C ₀ (stat)	M _{r0}	M _{p0}	M _{y0}	Block(g)		Rail(g/m)
MR 15WL EU/UZ	16	9	42	9.5	40	23	8x4.5x4.5	60	76.7	57.6	13	35	45	M4x4.5	1.8	3.3	4.5	6725	12580	257.6	93.1	93.1	203	2818	MR 15WL EU/UZ
MR 15WN EU/UZ	16	9	42	9.5	40	23	8x4.5x4.5	60	57.6	38.5	13.2	20	45	M4x4.5	1.8	3.3	4.5	5065	8385	171.1	45.7	45.7	140	2818	MR 15WN EU/UZ
MR 12WL EU/UZ	14	8	24	8.5	40	-	8x4.5x4.5	40	61.2	46	11.2	28	28	M3x3.5	1.3	3.1	4.5	4070	7800	95.6	56.4	56.4	96	1472	MR 12WL EU/UZ
MR 12WN EU/UZ	14	8	24	8.5	40	-	8x4.5x4.5	40	46.1	31	11.3	15	28	M3x3.5	1.3	3.1	4.5	3065	5200	63.7	26.3	26.3	68	1472	MR 12WN EU/UZ
MR 9WL EU/UZ	12	6	18	7.3	30	-	6x3.5x4.5	30	51.9	39.5	9.4	24	23	M3x3	1.3	2.6	4	2550	4990	45.9	26.7	26.7	51	940	MR 9WL EU/UZ
MR 9WN EU/UZ	12	6	18	7.3	30	-	6x3.5x4.5	30	40.4	27.9	9.6	12	21	M3x3	1.3	2.6	4	2030	3605	33.2	13.7	13.7	37	940	MR 9WN EU/UZ

Load capacities are calculated according to ISO 14728. To compare the rating life definition and the load capacities: C₅₀₈ = 1.26 x C₁₀₀₈



5. Dimensions and Specifications

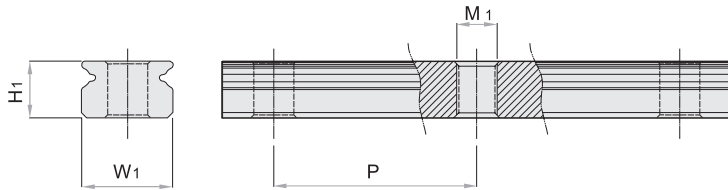

5.11 Standard MRU-M series - Tapped from bottom

Dimensions and Specifications

Model Code	Rail Dimensions (mm)			
	H1	W1	P	M1
MRU 15M	9.5	15	40	M4x0.7
MRU 12M	7.5	12	25	M4x0.7
MRU 9M	5.5	9	20	M4x0.7
MRU 7M	4.7	7	15	M3x0.5
MRU 5M	3.5	5	15	M3x0.5
MRU 3M	2.6	3	10	M1.6 x0.35

5.12 Wide MRU-W series - Tapped from bottom

Dimensions and Specifications

Model Code	Rail Dimensions (mm)			
	H1	W1	P	M1
MRU 15W	9.5	42	40	M5x0.8
MRU 12W	8.5	24	40	M5x0.8
MRU 9W	7.3	18	30	M4x0.7
MRU 7W	5.2	14	30	M4x0.7
MRU 5W	4	10	20	M3x0.5
MRU 3W	2.7	6	15	M3x0.5

6. Carbon Steel

Characteristic

1. Provided max length: 3m.
2. Hardness of the ball runner rail surface : HRC 58 ~ 63
Hardness of the center : About HRC 28
3. Applies to industrial machines in normal conditions.
4. Sizes are the same as with stainless steel products.
5. Very competitive prices.
6. Precision class available for N, H, and P Grade.
7. Product size, precision class, and other technical information are the same as the MR stainless series, please refer to the **cpc** MR Miniature Linear Guide Series Catalog for more information.

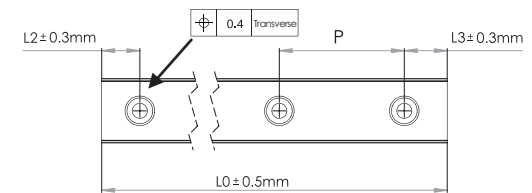
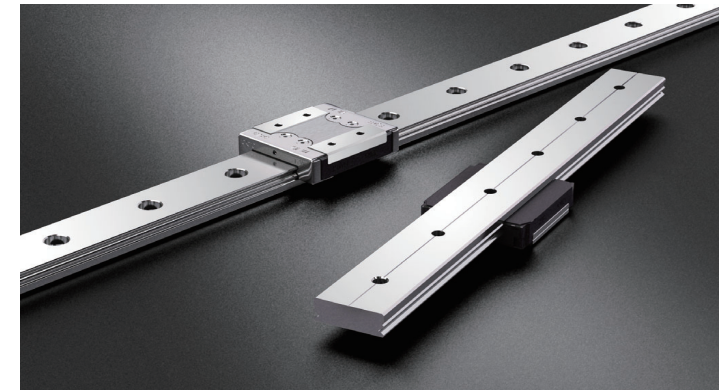
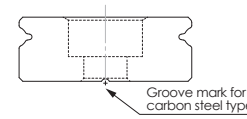

Suggestion length of one rail	Standard			Wide		
	9M	12M	15M	9W	12W	15W
Pitch (mm)	20	25	40	30	40	40
L2, L3 min	4	4	4	4	4	4
L2, L3 max	20	20	35	25	35	35
Maximum rail length L0 (mm)	3000	3000	3000	3000	3000	3000

6. Carbon Steel

Standard Rail

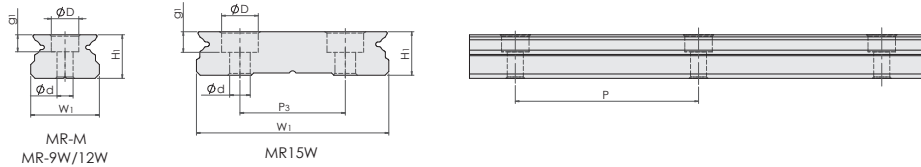

Standard MR-M series Rail

Model Code	Rail Dimensions(mm)				Weight(g/m)
	H ₁	W ₁	P	D _x d _x g ₁	
MR 15M	9.5	15	40	6x3.5x4.5	930
MR 12M	7.5	12	25	6x3.5x4.5	602
MR 9M	5.5	9	20	6x3.5x3.5	301

Wide MR-W series Rail

Model Code	Rail Dimensions(mm)					Weight(g/m)
	H ₁	W ₁	P	P ₃	D _x d _x g ₁	
MR 15W	9.5	42	40	23	8x4.5x4.5	2818
MR 12W	8.5	24	40	-	8x4.5x4.5	1472
MR 9W	7.3	18	30	-	6x3.5x4.5	940



ST Miniature Stroke Slide series

Tapped Rail

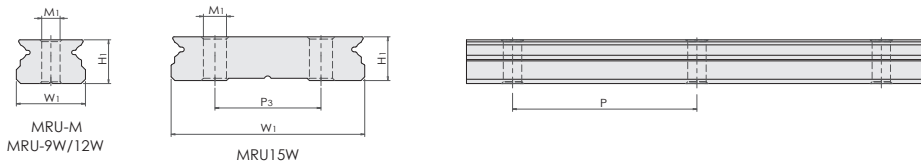

Standard MRU-M series - Tapped from bottom

Model Code	Rail Dimensions(mm)				Weight(g/m)
	H ₁	W ₁	P	M ₁	
MRU 15M	9.5	15	40	M4x0.7	930
MRU 12M	7.5	12	25	M4x0.7	602
MRU 9M	5.5	9	20	M4x0.7	301

Wide MRU-W series - Tapped from bottom

Model Code	Rail Dimensions(mm)					Weight(g/m)
	H ₁	W ₁	P	P ₃	M ₁	
MRU 15W	9.5	42	40	23	M5x0.8	2818
MRU 12W	8.5	24	40	-	M5x0.8	1472
MRU 9W	7.3	18	30	-	M4x0.7	940

1. Product Introduction

High load and high moment capacity

The ST Miniature Stroke Slide Series is designed with two rows of balls. The ball track has a gothic profile design with a 45 degree contact angle to achieve equal load capacity in a mono block. This provides more space for the larger rolling elements while enhancing the load and moment capacity.

High running accuracy and smoothness

The steel balls of the ST miniature stroke slide series roll on the rail without recirculation, resulting in excellent running behavior, smoothness, low friction, and high accuracy without vibration.

Dual plate design

The ST Miniature Stroke Slide Series adopts a pair of end plates into the design. Both the center rail and bearing block sides have a plate installed that prevents the linear guide from over-stroking.

Easy mounting

The mounting of the ST Miniature Stroke Slide Series is accomplished by fitting the fixing screw downward into the count bore of the rail by intersecting the hole pattern on the block and cage within the hole pitch. The one piece cage therefore does not influence the mounting of the rail while the preload is preset by ball sorting.



Temperature

The ST Miniature Stroke Slide Series can withstand temperatures of up to 150 °C. There are two treatment options for higher temperature applications:

T1 : 200°C
T2 : 300°C

Applying treatments for higher temperature applications will reduce the load capacity.

Anti-corrosion feature

The ST Miniature Stroke Slide Series is composed of quenched hardened process stainless steel for the rail, block, and steel balls. The block plate and screws are made of stainless steel as well – providing a great model for maintenance and inspection applications.

2. Technical Information

Accuracy

The ST Miniature Stroke Slide Series has three grades for accuracy. Precision (P), High (H) and Normal (N).

Preload

The ST Miniature Stroke Slide series has two preload classes, V0 and V1, as described in the MR miniature linear guide series preload table.

Geometric and positional accuracy of the mounting surface

The inaccuracy of the mounting surfaces will affect the running accuracy and reduce the operating lifetime of the ST Miniature Stroke Slide. If the inaccuracies of the mounting surface exceed the values calculated by formulas (15), (21), and (17), the lifetime will be shortened, as calculated by formulas (19) and (20).

$$e_{1(mm)} = b_{(mm)} \cdot f_1 \cdot 10^{-4} \quad \text{--- (15)}$$

$$e_{2(mm)} = \left(\frac{d}{L_C} \right) \cdot f_2 \cdot 10^{-5} \quad \text{--- (21)}$$

$$e_{3(mm)} = f_3 \cdot 10^{-3} \quad \text{--- (17)}$$

Rating life calculation

$$L = K_{st} \left(\frac{C_{1008}}{P} \right)^3 \cdot 10^5 \quad \text{--- (19)}$$

$$L_h = \frac{L}{2 \cdot s \cdot n \cdot 60} = K_{st} \cdot \frac{L}{v_m \cdot 60} \quad \text{--- (20)}$$

Short stroke factor diagram

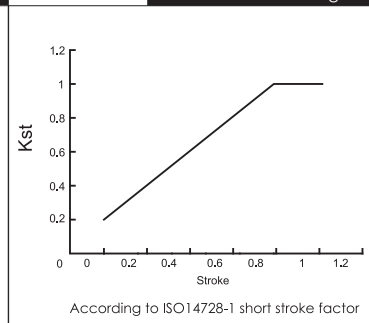

The mounting surface geometric and positional accuracy factor

Size	V0			V1		
	f ₁	f ₂	f ₃	f ₁	f ₂	f ₃
7	5	200	4	3	130	3
9	5	300	6	4	200	4
12	6	380	8	4	250	6
15	7	530	12	5	350	8

Ordering designation

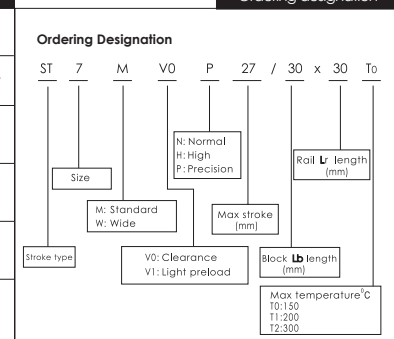

Lubrication

Lubrication of the ST Miniature Stroke Slide Series can be performed by adding the lubricant onto the raceway of the rail.

Rating life L

The rating life of the ST Miniature Stroke Slide Series can be calculated by formulas (19) and (20), in accordance with ISO 14728-1.

Height and Chamfered Reference Edge

The tables for the chamfered reference edge corner and the height of the reference edge for the MR Miniature Linear Guide Series are also suitable for the ST Miniature Stroke Slide Series.

3. Ordering Information

An example of the ST Miniature Stroke Slide Series part numbering system is shown above.

4. Dimensions and Specifications

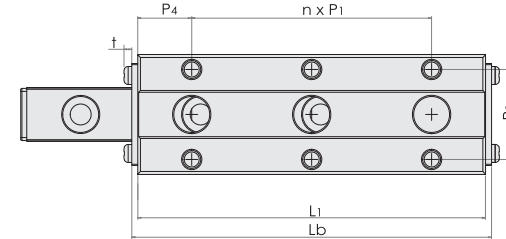
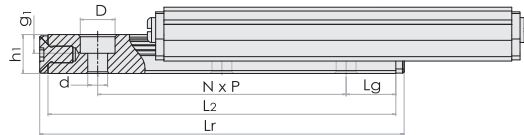
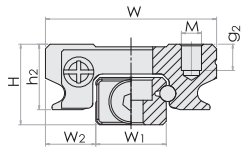

Model Code	Fabricate Dimensions (mm)		Rail Dimensions (mm)				Block Dimensions (mm)						Model Code
	H	W ₂	P	W ₁	h ₁	D x d x g ₁	P ₁	P ₂	W	h ₂	M x g ₂	t	
ST7M	8	5	15	7	4.7	4.2x2.4x2.3	15	12	17	6.5	M2x2.5	1	ST7M
ST9M	10	5.5	20	9	5.5	6x3.5x3.5	20	15	20	7.8	M3x3.0	1.3	ST9M
ST12M	13	7.5	25	12	7.5	6x3.5x4.5	25	20	27	10	M3x3.5	1.3	ST12M

Model Code	Max Stroke	Rail Dimensions (mm)				Block Dimensions (mm)				Load Capacities (N)		Static Moment (Nm)		
	L _s	L _r	L ₂	L _g	N	L _b	L ₁	P ₄	n	C _{100s} (dyn)	C ₀ (stat)	M _{r0}	M _{p0}	M _{y0}
ST7M	27	30	28	6.5	1	30	28	6.5	1	910	1580	5.9	3.4	3.4
ST7M	41	45	43	6.5	2	45	43	6.5	2	1220	2500	9.1	8	8
ST7M	55	60	58	6.5	3	60	58	6.5	3	1490	3330	12.4	14.6	14.6
ST9M	38	40	38	9	1	40	38	9	1	1590	2773	13.1	6.8	6.8
ST9M	58	60	58	9	2	60	58	9	2	2080	4170	19.7	16	16
ST9M	78	80	78	9	3	80	78	9	3	2520	5547	26.2	29.2	29.2
ST12M	44	50	47.4	11.2	1	50	47.4	11.2	1	2550	4340	27	16	16
ST12M	69	75	72.4	11.2	2	75	72.4	11.2	2	3350	6510	40.1	35.6	35.6
ST12M	94	100	97.4	11.2	3	100	97.4	11.2	3	4050	8670	54	62.8	62.8

Linear Guide Service Life Calculation and Model Selection

Company /		Date (DD/MM/YEAR) /	
Address /		Tel /	
Contact /	Department /	Machine Model /	
Application(Axial) /	Amount required per Machines /	Sample Required Date (DD/MM/YEAR)/	
Application Drawing Provided? <input type="checkbox"/> Yes <input type="checkbox"/> No		Production Date (DD/MM/YEAR)/	
Assembly Specification / Way of Assembling			
Rails per Axial	<input type="checkbox"/> I (1)	<input type="checkbox"/> II (2)	<input type="checkbox"/> III (3) <input type="checkbox"/> Other _____
Blocks per Rail	<input type="checkbox"/> 1	<input type="checkbox"/> 2	<input type="checkbox"/> 3 <input type="checkbox"/> Other _____
Distribution of Blocks (mm)	l_{D0} : _____ (Distance Between Blocks on the same rail)		l_{D1} : _____ (Distance Between Adjacent Blocks on different rails)
Center of Mass of load(mm)	l_{mx} : _____	l_{my} : _____	l_{mz} : _____
Mass of Load (kg)	_____ (Please include mounting plate weight)		
Driver Position (mm)	l_{dz} : _____	l_{dy} : _____	
External Force Applying Position (mm)	l_{Fx} : _____	l_{Fy} : _____	l_{Fz} : _____
Axial Component (N)	F_x : _____	F_y : _____	F_z : _____
One Rail Per Axial			
Two Rails Per Axial			
Motion Specification			
Drive Mechanism	<input type="checkbox"/> Linear Motor <input type="checkbox"/> Ball Screw <input type="checkbox"/> Pneumatic Cylinder <input type="checkbox"/> Belt <input type="checkbox"/> Hydraulic cylinder <input type="checkbox"/> Rack and Pinion <input type="checkbox"/> Manual <input type="checkbox"/> Other _____		
Specification	Stroke Distance (mm): _____		Maximum Speed (m/sec): _____
	Acceleration (m/sec ²): _____		Deceleration (m/sec ²): _____
	Stroke Time (sec): _____		Frequency (hr ⁻¹): _____
	Daily Operation Time (hr): _____		Expected Service Life (Year): _____
Environment and Lubrication Requirements			
Environment	<input type="checkbox"/> General <input type="checkbox"/> Clean room (Grade/Class _____) <input type="checkbox"/> Vacuum / Low Pressure <input type="checkbox"/> Small Amount of Dust (Substance _____) <input type="checkbox"/> Large Amount of Dust (Substance _____) <input type="checkbox"/> Liquid (Substance _____) <input type="checkbox"/> Special Gas (Substance _____) <input type="checkbox"/> Other _____		
cpc Initial Lubrication	<input type="checkbox"/> Pre-lubricated (Regular Amount) <input type="checkbox"/> Pre-lubricated (Small Amount) <input type="checkbox"/> None <input type="checkbox"/> Other _____		
cpc Initial Antirust Method	<input type="checkbox"/> Apply Antirust Oil On the Surface <input type="checkbox"/> Apply Grease On the Surface <input type="checkbox"/> None <input type="checkbox"/> Other _____		
Customer Initial Lubrication	<input type="checkbox"/> cpc Grease only <input type="checkbox"/> In addition to cpc Grease, Inject Customer's Grease (Grease : _____) <input type="checkbox"/> Remove cpc Grease And Inject Customer's Grease (Solvent: _____) (Grease: _____) <input type="checkbox"/> Other _____		
End User Re-lubrication Method	<input type="checkbox"/> Manual <input type="checkbox"/> Central Oiling System <input type="checkbox"/> None <input type="checkbox"/> Other _____		

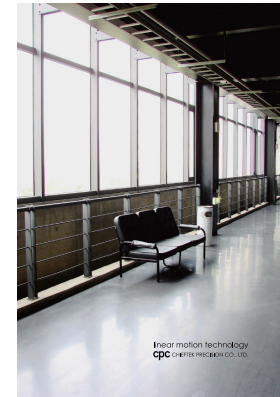

linear motion technology
cpc-america.com



linear motion technology
cpc-america.com